

# HC25-1

Montagekit für Kapazitiv-  
sensoren CFDK 25

Mounting kit for capacitive-  
sensors CFDK 25

Kit de montage pour les dé-  
tecteurs capacitifs CFDK 25



11053652



Baumer Electric AG · CH-8501 Frauenfeld  
Phone +41 (0)52 728 1122 · Fax +41 (0)52 728 1144

**Canada**  
Baumer Inc.  
CA-Burlington, ON L7M 4B9  
Phone +1 (1)905 335-8444

**China**  
Baumer (China) Co., Ltd.  
CN-201612 Shanghai  
Phone +86 (0)21 6768 7095

**Denmark**  
Baumer A/S  
DK-8210 Aarhus V  
Phone +45 (0)8931 7611

**France**  
Baumer SAS  
FR-74250 Fillinges  
Phone +33 (0)450 392 466

**Germany**  
Baumer GmbH  
DE-61169 Friedberg  
Phone +49 (0)6031 60 07 0

**India**  
Baumer India Private Limited  
IN-411038 Pune  
Phone +91 20 2528 6833/34

**Italy**  
Baumer Italia S.r.l.  
IT-20090 Assago, MI  
Phone +39 (0)2 45 70 60 65

**Singapore**  
Baumer (Singapore) Pte. Ltd.  
SG-339412 Singapore  
Phone +65 6396 4131

**Sweden**  
Baumer A/S  
SE-56133 Huskvarna  
Phone +46 (0)36 13 94 30

**Switzerland**  
Baumer Electric AG  
CH-8501 Frauenfeld  
Phone +41 (0)52 728 1313

**United Kingdom**  
Baumer Ltd.  
GB-Watchfield, Swindon, SN6 8TZ  
Phone +44 (0)1793 783 839

**USA**  
Baumer Ltd.  
US-Southington, CT 06489  
Phone +1 (1)860 621-2121

## Abmessungen Dimensions Dimension

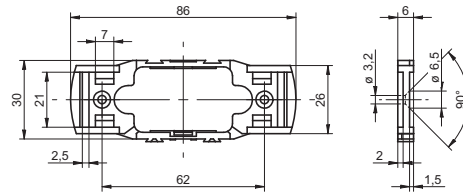

Material: PA 12

- Alle Masse in mm
- All dimensions in mm
- Toutes les dimensions en mm

## Inhalt Montagekit Content mounting kit Contenu de kit de montage

1x Montagerahmen HC25  
1x mounting frame HC25  
1x cadre de montage HC25

2x Kabelbinder 186x4,7mm  
2x cable ties 186x4,7mm  
2x colliers serre-câbles 186x4,7 mm

2x Klebepads  
2x adhesive pads  
2x supports adhésifs

2x Distanznocken  
2x spacers  
2x entretoises

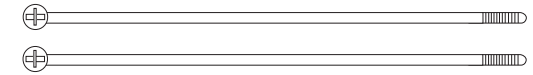
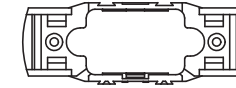

## Snap-in Ohne Werkzeug Without tools Sans outils

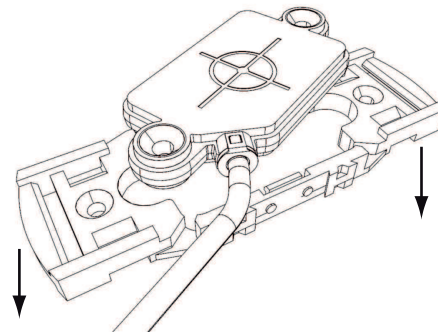

1. Rahmen befestigen  
1. Fix the frame  
1. Fixer le cadre

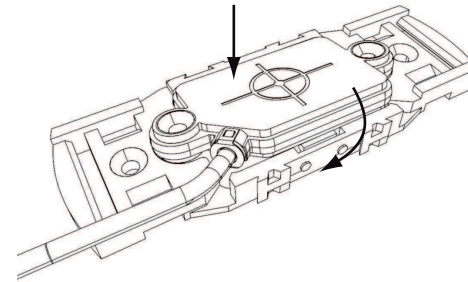

2. Sensor einklicken  
2. Snap in the sensor  
2. Encliqueter le détecteur

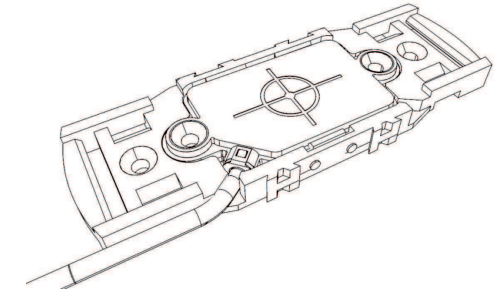

3. Fertig  
3. Ready  
3. Terminé

**Montage auf Rohre**  
**Mounting on tubes**  
**Montage sur tubes**

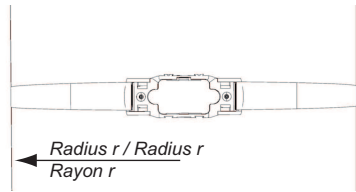

Radius des Rohrs  
 Radius of the tube  $r < 80$  mm  
 Rayon de tube

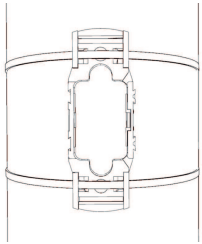

Montage parallel zur Rohrachse  
 Installation parallel to the tube axis  
 Montage parallèlement à l'axe du tube

Radius des Rohrs  
 Radius of the tube  $r = 80 - 160$  mm  
 Rayon de tube



Montage mit Distanznocken  
 Mounting with spacers  
 Montage avec entretoises

Radius des Rohrs  
 Radius of the tube  $r > 160$  mm  
 Rayon de tube



Keine Distanznocken nötig  
 No spacer necessary  
 Sans entretoises

**Fixierung mit Klebepads oder Klebstoff**  
**Fixation with adhesive pads or glue**  
**Fixation avec supports adhésifs ou avec de la colle**

Fixierung mit Klebepads  
 Fixation with adhesive pads  
 Fixation avec supports adhésifs

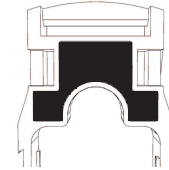

- Anweisung
1. Zu verklebende Flächen mit Aceton reinigen
  2. Klebepads auf den Montagerahmen kleben
  3. Kurz auf Ebene Fläche aufpressen

- Instructions
1. Clean gluing surfaces with acetone
  2. Apply the adhesive pads on the mounting frame
  3. Press down on level surface

- Instructions
1. Nettoyer les surfaces à coller avec de l'acétone
  2. Appliquer les supports adhésifs sur le cadre de montage
  3. Presser le cadre sur une surface plane

Fixierung mit Klebstoff  
 Fixation with glue  
 Fixation avec de la colle

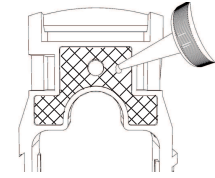

- Klebeanweisung
1. Zu verklebende Flächen mit Aceton reinigen
  2. Kleber (Epoxy; MS-Polymer) auf Klebeflächen auftragen
  3. Bis zur vollständigen Aushärtung auf Ebene Fläche aufpressen

- Gluing instructions
1. Clean gluing surfaces with acetone
  2. Apply glue (epoxy; MS polymer) to gluing surfaces
  3. Press down on level surface until fully hardened

- Instructions pour le collage
1. Nettoyer les surfaces à coller avec de l'acétone
  2. Appliquer la colle (époxy, MS-Polymère), sur les surfaces à coller
  3. Sur une surface plane, presser les supports jusqu'au durcissement complet de la colle

**Montagearten**  
**Mounting versions**  
**Types de montage**

Mit Kabelbinder  
 With cable ties  
 Avec colliers serre-câbles

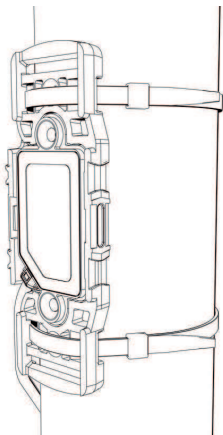

Mit Klettband  
 With Velcro strip  
 Avec bande Velcro

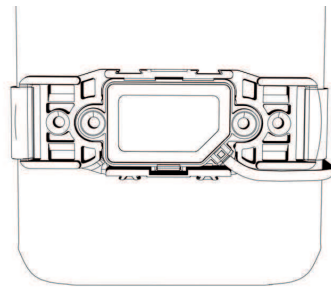

Kaskadierte Montage  
 Cascaded mounting  
 Montage en cascade

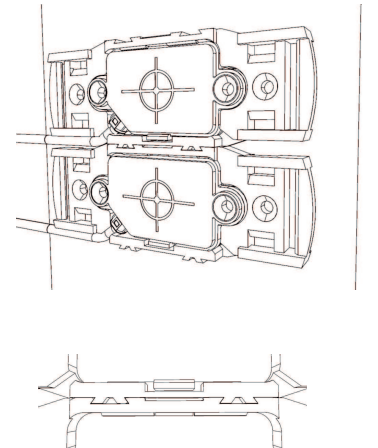

Fixierung mit Klebepads oder Klebstoff  
 Fixation with adhesive pads or glue  
 Fixation avec supports adhésifs ou avec de la colle

