

microGen
Energy Harvesting

Operating Manual

Z-PA.SDL.1 WLAN adapter

Programming device for HMG10P/PMG10P series

EN-US

List of contents

1	About this document	4
1.1	Purpose	4
1.2	Warnings in this manual	4
1.3	Labels in this manual	4
1.4	Disclaimer	4
1.5	Scope of delivery	5
1.6	Name plate	5
1.7	Maintenance and service life	5
1.8	Approvals and warranty	6
1.9	Temperature range for operation and storage	6
2	General information	7
3	Transport and storage	8
3.1	Transport	8
3.2	Delivery inspection	8
3.3	Storage	8
4	Description	9
4.1	Functionality	9
4.2	Required connection accessories (not included in the delivery)	10
4.2.1	For HMG10P/PMG10P with mating flange connector(s)	10
4.2.2	For HMG10P/PMG10P with SSI terminal box	11
4.2.3	For HMG10P/PMG10P with bus terminal box	12
5	Connecting the WLAN adapter to encoder	13
6	Electrical installation	14
6.1	Pin assignment at programmer D-SUB port	14
6.2	RESET button	15
6.3	Application modes	15
6.3.1	OFFLINE mode	15
6.3.2	ONLINE mode	16
6.4	Initial connection of programmer to the network	16
6.4.1	Establishing P2P connection with network cable	17
6.4.2	Establishing WLAN connection	17
6.5	Establish connection to programmer via web browser	18
7	Web interface description	20
7.1	Settings: Language and units	20
7.2	Service access	20
7.3	System	21
7.3.1	Network settings (LAN)	21
7.3.2	WLAN settings	22
7.3.3	System control panel	23

7.4	Firmware update	23
7.5	Encoder parameters.....	24
7.6	Parameter Download	25
7.7	Encoder monitoring	26
8	Technical data	27
8.1	Dimensions	27
9	Licenses	28

1 About this document

1.1 Purpose

This operating manual (subsequently referred to as *manual*) allows the safe and efficient handling of the product .

The manual does not provide instructions on operating the machine in which the product is integrated. Information on this is found in the operating manual of the machine.

The manual is a constituent part of the product. It must be kept in the immediate vicinity of the product and must be accessible to personnel at all times.



Personnel must have carefully read and understood this manual before beginning any work. The basic prerequisite for safe working is compliance with all safety instructions and handling instructions given in this manual.

In addition, the local occupational health and safety regulations and general safety regulations apply.

The illustrations in this manual are examples only. Deviations are at the discretion of Baumer at all times.

1.2 Warnings in this manual

Warnings draw attention to potential personal injury or material damage. The warnings in this manual indicate different hazard levels:

Symbol	Warning term	Explanation
	DANGER	Indicates an imminent potential danger with high risk of death or serious personal injury if not being avoided.
	WARNING	Indicates potential danger with medium risk of death or (serious) personal injury if not being avoided.
	CAUTION	Indicates a danger with low risk, which could lead to light or medium injury if not avoided.
	NOTE	Indicates a warning of material damage.
	INFO	Indicates practical information and tips that enable optimal use of the devices.

1.3 Labels in this manual

Identifier	Usage	Example
Dialog element	Indicates dialog elements.	Click the OK button.
Unique name	Indicates the names of products, files, etc.	<i>Internet Explorer</i> is not supported in any version.
Code	Indicates entries.	Enter the following IP address: 192.168.0.250

1.4 Disclaimer

The manufacturer is not liable for personal injury and/or property damage resulting from improper use of the device.

1.5 Scope of delivery

Delivery includes:

- 1x Z-PA.SDL.1 WLAN adapter
- 1x power connector with adapter plug for different countries

In addition, the following documentation is accessible in digital form at www.baumer.com:

- Operating manual
- Declaration of Conformity
- Connection cables

1.6 Name plate

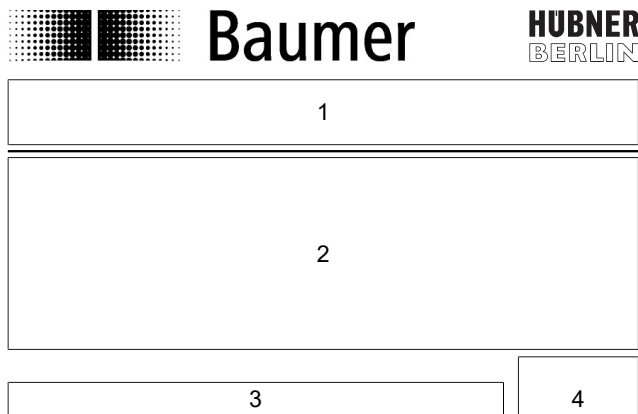

1	Product name, product code, material number	2	Serial number, technical data, MAC address
3	Baumer Website	4	Labels

1.7 Maintenance and service life

The device may only be opened for assembly and maintenance work as described in the present instruction manual. Any repair or maintenance work requiring fully opening the device must be carried out by the manufacturer only.

Do not perform any modifications at the device.

For any queries or subsequent deliveries refer to the product data specified on the device label, in particular type and serial number.

1.8 Approvals and warranty

Declaration of conformity according to the prevailing country-specific directives.

We grant a 2-year warranty in line with the conditions of the German Electrical and Electronic Manufacturers' Association (ZVEI).

INFO

warranty seal

Any breaking of the seal provided at the device will result in loss of warranty.

1.9 Temperature range for operation and storage

The storage temperature of the device ranges from -15 ... +70 °C

The device operating temperature range ranges between 0° ... 40 °C, measured at housing.

2 General information

Intended use

The Z-PA.SDL.1 WLAN adapter is for programming and monitoring the HMG10P/PMG10P encoder series.

The product is only intended for use in industrial working environments.

Commissioning

Assembly, installation, and calibration of this product may only be performed by a specialist.

Disposal (environmental protection)



Used electrical and electronic devices may not be disposed of in household waste. The product contains valuable raw materials that can be recycled. Therefore dispose of this product at the appropriate collection point. For additional information visit www.baumer.com.

3 Transport and storage

3.1 Transport

NOTICE

Material damage due to improper transport.

- a) Ensure maximum diligence when unloading the delivered packages as well as when transporting them inside the company.
- b) Note the information and symbols on the packaging.
- c) Only remove packaging immediately before mounting.

3.2 Delivery inspection

Upon receipt immediately inspect the delivery for completeness and transport damage.

Claim any defect as soon as it is detected. Damages can only be claimed within the applicable claims deadlines.

In case of externally visible transport damage, proceed as follows:

Instruction:

- a) Do not accept the delivery or only with reservations.
- b) Note the scope of the damage on the transport documents or the delivery slip of the carrier.
- c) Initiate the claim.

3.3 Storage

Store the product at the following conditions:

- Only transport or store the device in its original packaging.
- Do not store outdoors.
- Store dry and free from dust.
- Do not expose to aggressive media.
- Keep away from the sun.
- Avoid mechanical agitation.
- Storage temperature: -15 ... +70 °C.
- Ambient humidity:.
- When storing for longer than 3 months, regularly check the general state of all parts and the packaging.

4 Description

4.1 Functionality

The Z-PA.SDL.1 WLAN adapter is for programming and monitoring the HMG10P/PMG10P encoder series.

The encoder parameters below enable parameterization (depending on encoder version). Doing so requires registration as "ADMIN":

- Resolution Singleturn (SSI)
- Resolution Multiturn (SSI)
- Binary or Gray Code (SSI)
- Additional output 1 and 2 (number of pulses per revolution)
- Switch off / on speed

Configuration and operation of the programming device is via web browser



INFO

WLAN Internet connection in parallel with WLAN connection established for the programmer is not possible.

4.2 Required connection accessories (not included in the delivery)

4.2.1 For HMG10P/PMG10P with mating flange connector(s)



INFO

The M23 T-piece does not provide encoder power supply via the programmer (pins 7 + 10 not assigned).

Order number	Version
11210827	Round connector M23, 17-pin, ccw with connection cable and 15-pin D-SUB connector for OFFLINE mode
11191143	Round connector M23, 17-pin, ccw with connection cable and 15-pin D-SUB connector for OFFLINE mode T-element M23, 3x 17-pin for ONLINE mode

A = Encoder connection

B = looped-through encoder signals, connected to the controller

X = Programming interfaces for encoder connection

Y = D-SUB connector for programmer connection

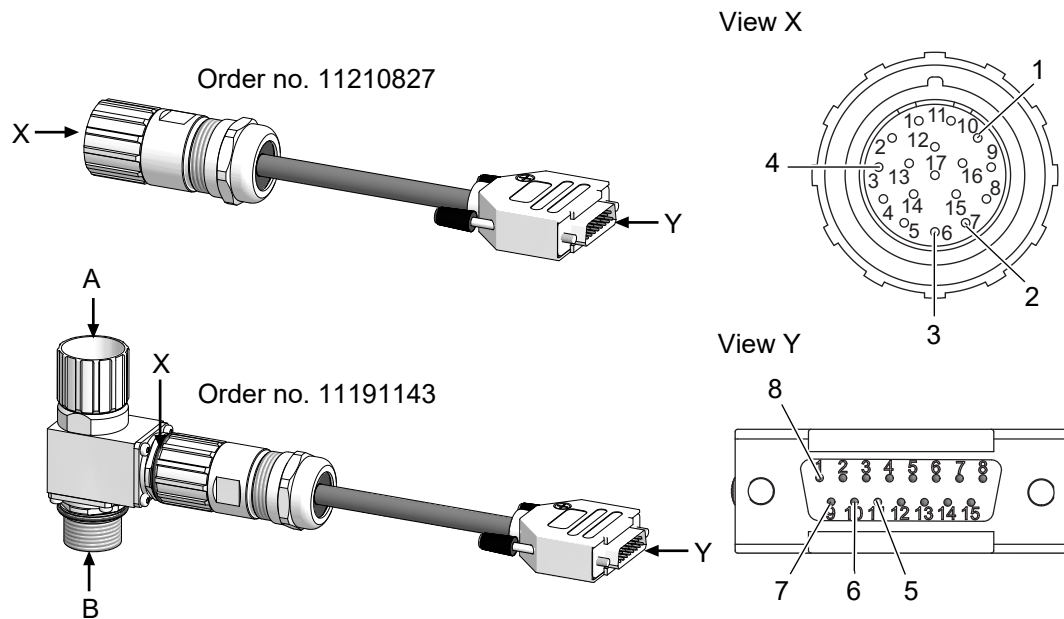

1	\perp 0 V (Pin 10)	2	+UB (Pin 7)
3	SA (Pin 6) ^I	4	SB (Pin 3) ^{II}
5	SB (Pin 11)	6	SA (Pin 10)
7	+UB (Pin 9)	8	\perp 0 V (Pin 1)

^I SA = RS485+

^{II} SB = RS485-

4.2.2 For HMG10P/PMG10P with SSI terminal box



INFO

For ONLINE mode the connection terminal can be detached and the cable ends SA (green) and SB (yellow) can be directly connected to the encoder terminals or to any existing cables of the machine/control cabinet (customer installation). Encoder operating voltage supply is via the machine/ controller.

Order number

11191144

Version

15-pin D-SUB connector with connection cable and 8-pin terminal block for plug-on encoder connection.

Y = D-SUB connector for programmer connection

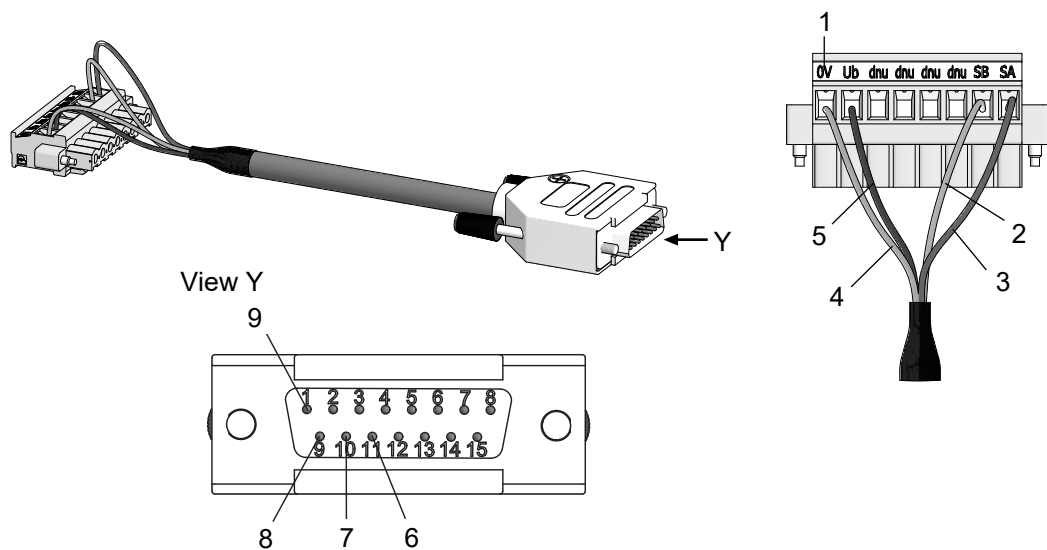

1	Terminals Terminal box [A]	2	SB (yellow) ^I
3	SA (green) ^{II}	4	+UB (brown)
5	⊥ 0 V (white)	6	SB (Pin 11)
7	SA (Pin 10)	8	+UB (Pin 9)
9	⊥ 0 V (Pin 1)		

^I SB = RS485-

^{II} SA = RS485+

4.2.3 For HMG10P/PMG10P with bus terminal box



INFO

For ONLINE mode the connection terminal can be detached and the cable ends SA (green) and SB (yellow) can be directly connected to the encoder terminals or to any existing cables of the machine/control cabinet (customer installation). Encoder operating voltage supply is via the machine/ controller.



INFO

Versions with bus terminal box utilize encoder supply via the bus terminal box.

Order number
11191145

Version
15-pin D-SUB connector with connection cable, 9 and 7-pin D-SUB terminal block for encoder plug on.

Y = D-SUB connector for programmer connection

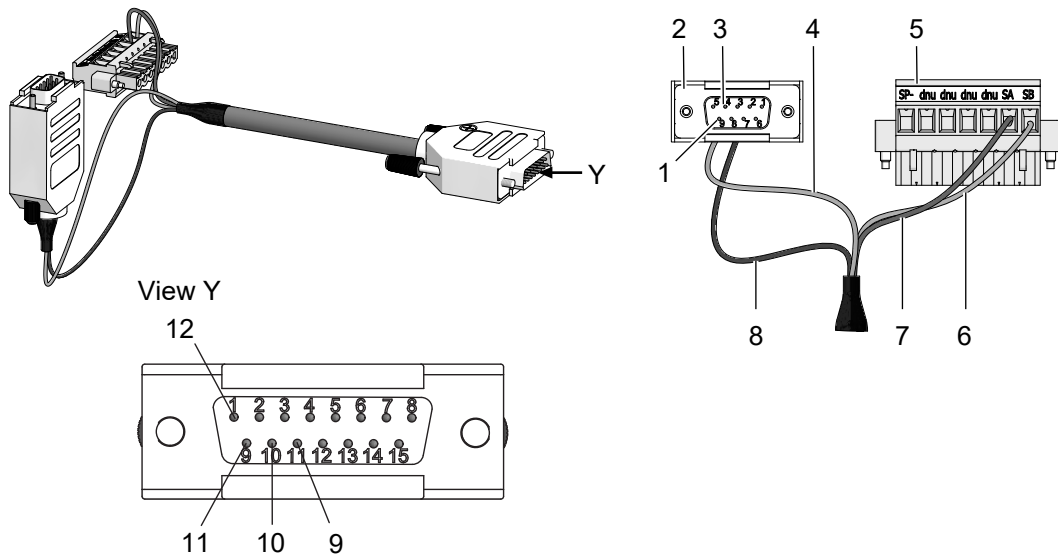

1	+UB (9)	2	D-SUB Stecker Bus terminal box [A]
3	⊥ 0 V (Pin 4)	4	⊥ 0 V (white)
5	Terminals Terminal box [B]	6	SB (yellow) ^I
7	SA (green) ^{II}	8	+UB (brown)
9	SB (Pin 11)	10	SA (Pin 10)
11	+UB (Pin 9)	12	⊥ 0 V (Pin 1)

^I SB = RS485-

^{II} SA = RS485+

5 Connecting the WLAN adapter to encoder

⚠ DANGER

Risk of injury by rotating shafts

- a) When connecting programmer to encoder, make sure that each machine connected to the encoder is down and protected against any inadvertent switchon.
- b) During encoder programming, keep sufficient distance to rotating shafts.
- c) Only use power unit included in the delivery for programmer power supply

Instruction:

- a) Connect the encoder using a 15-pin D-SUB connector 15-pin to the mating 15-pin D-SUB port of the programmer.
The adapter cable is available as an accessory.
- b) Connect the network cable to the Ethernet port (not required if programmer is connected via WLAN).
- c) Connect the programmer to power supply.
 - ✓ The LED next to the mating D-SUB port is flashing blue.
 - ✓ As soon as the LED is green continuous, the programmer is operational.

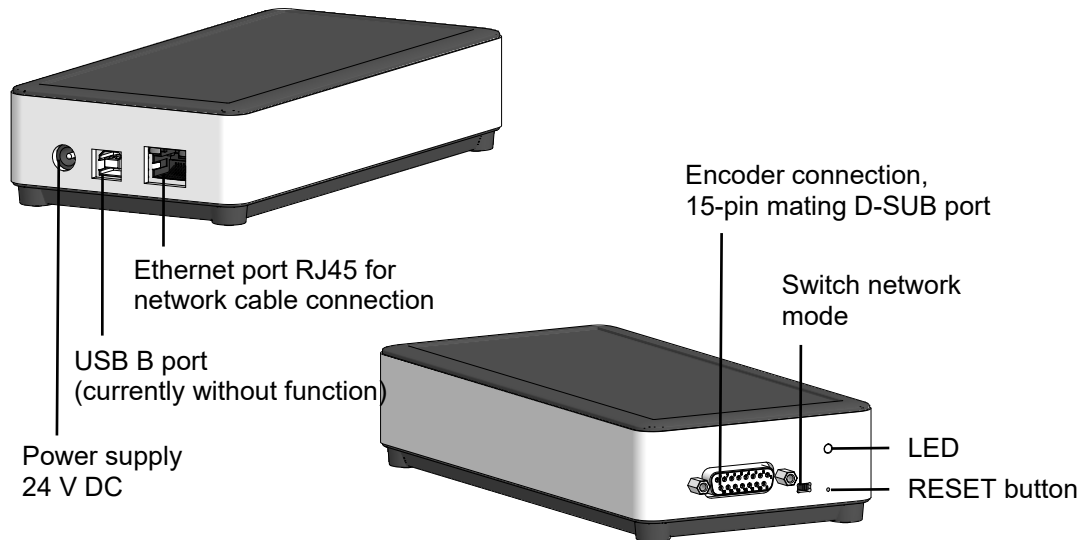

6 Electrical installation

⚠ DANGER

Injury by secondary damage

Failure or signal errors by connected sensors may entail system control errors.

- a) Eliminate secondary damage by relevant safety precautions in the downstream electronics.

NOTICE

Damage to the WLAN adapter due to incorrect supply voltage.

Incorrect supply voltage may damage the WLAN adapter.

- a) Only operate the WLAN adapter using the included power unit.

NOTICE

Sensor damage or unintended operation due to work on live parts.

Work on live parts may lead to unintentional operation.

- a) Disconnect the power before carrying out any cable.
- b) Disconnect the power before connecting or disconnecting electrical connections.

6.1 Pin assignment at programmer D-SUB port

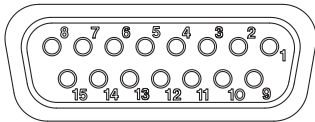

Port	Assignment
1	GND
2	SSI CLOCK+
3	SSI CLOCK-
4	SSI DATA+
5	SSI DATA-
6	Analog
7	Do not use
8	Do not use
9	Encoder supply
10	SA (RS485+)
11	SB (RS485-)
12	INC
13	Do not use
14	C AN HIGH
15	C AN LOW

6.2 RESET button

The RESET button can be used for programmer shut down, restart or restore default.

Press RESET button with a pointed object (e.g. paper clip) and hold for ...

for >0.3 seconds	Programmer is shut down.	Green LED is flashing green 1x
for >2 seconds	Executing programmer restart.	Green LED is flashing green 2x
for >5 seconds	Restoring default in programmer.	Green LED is flashing green 3x
for >10 seconds	Abort operation.	LED is green continuous

6.3 Application modes

The programmer can integrate in the encoder-controller connection (ONLINE) or be connected autonomously to an encoder (OFFLINE).

In autonomous use, external power supply is provided via the programmer. From the machine control point of view, programmer data access is completely non-interacting.

6.3.1 OFFLINE mode

Use cases for OFFLINE mode are pre-parameterization, function diagnostics or commissioning of an encoder.

Here, the encoder is not in installed condition. Encoder operating voltage supply is provided by the programmer. Programmer power supply requires a separate source.



INFO

Encoder parameterization is password protected and requires **ADMIN** access rights.

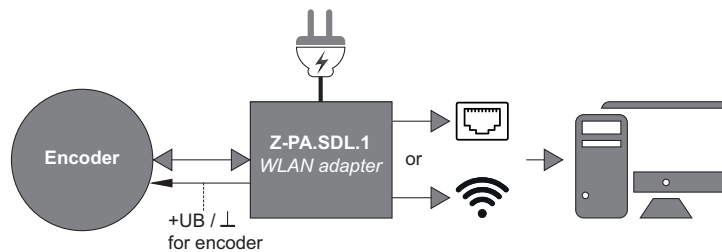

III. 1: Programmer connection in OFFLINE mode

6.3.2 ONLINE mode

Use cases for ONLINE mode are monitoring, diagnostics and parameterization of an encoder in installed condition.

In this case, the encoder is installed in a machine or facility. Encoder operating voltage supply is by the machine/ controller. Programmer power supply requires a separate source.



INFO

Encoder parameterization is password protected and requires **ADMIN** access rights.

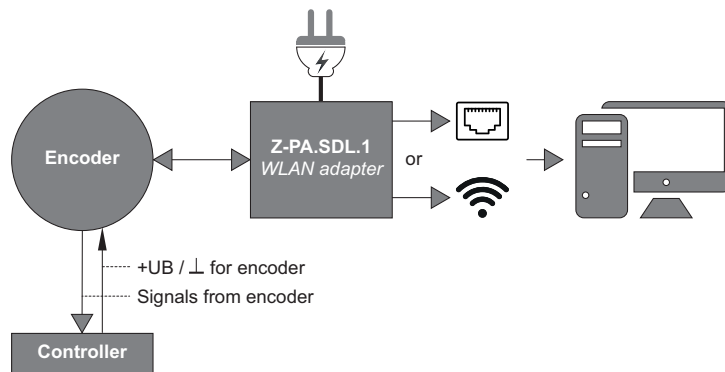

III. 2: Programmer connection in ONLINE mode

6.4 Initial connection of programmer to the network

Encoder programming via web browser requires an established network connection with the programmer.

All end devices with web browser (PC, smartphone, tablet ...) that are WLAN-capable or with Ethernet interface can be connected..



INFO

Only one device at a time can access the programmer via web browser.

Disconnect any existing web browser connections, otherwise an error message will appear.



INFO

Existing network protection and firewalls may prevent programmer communication. Please contact your IT Support..

6.4.1 Establishing P2P connection with network cable

Using a network cable, you can establish a direct network connection to the programmer.

Instruction:

- a) Set the Network Mode switch to "P2P".
- b) Connect PC and programmer with the network cable.

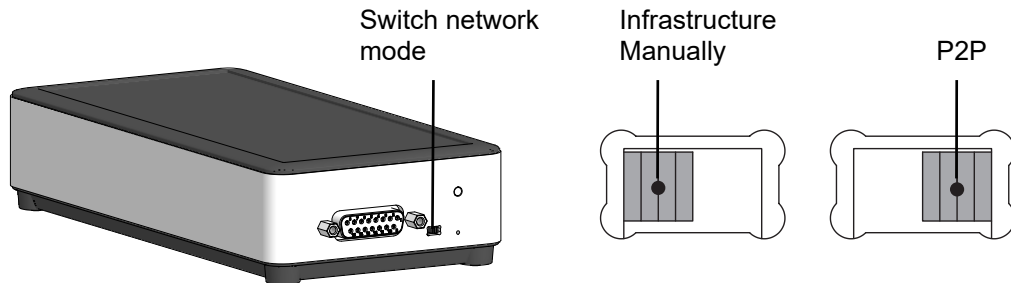

III. 3: Switch network mode

Also see about this

[Network settings \(LAN\) \[▶ 21\]](#)

6.4.2 Establishing WLAN connection

The illustration below shows how to establish WLAN connection to a PC running the Windows operating system. For devices/operating running other systems (macOS, iOS, Android, ...), observe the respective descriptions for establishing WLAN connection. Here, the programmer will act as an access point.

Instruction:

- a) Open the WLAN connection manager.
- b) Select WLAN SSID **Baumer.Sensor.xxxx** and start the connection.
- c) Enter the password.



INFO

WLAN SSID and password can be found on the programmer label and can be edited in the web browser.



INFO

WLAN Internet connection in parallel with WLAN connection established for the programmer is not possible.



III. 4: Establishing WLAN connection in the Windows operating system

6.5 Establish connection to programmer via web browser

Network connection to the programmer having been established enables direct access via web browser.

Instruction:

- a) Open the web browser.
- b) Go to website <http://baumer.sensor>(alternatively, call IP address 10.0.0.1)
 - ✓ Window **Connection** opens for connection to the connected encoder.

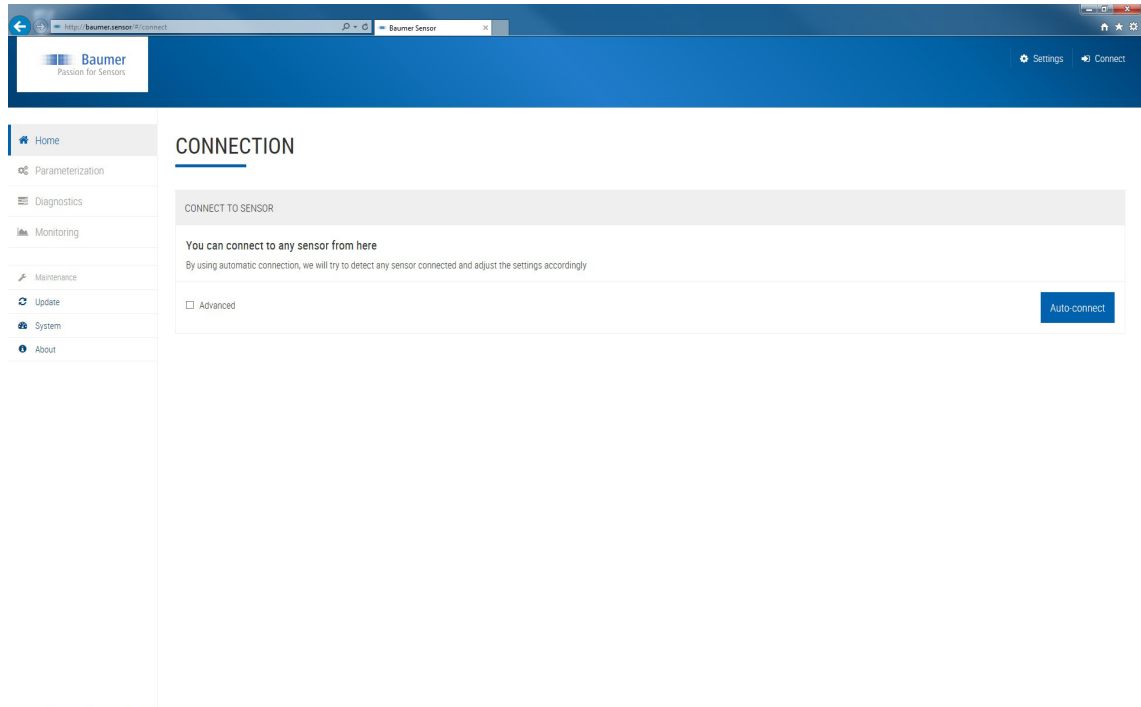

- c) Select **Automatically connect** to automatically establish connection between encoder and programmer.

d) In the event the connection to the connected encoder is not automatically established, perform the settings yourself at **Advanced**.

✓ The programmer has been connected.

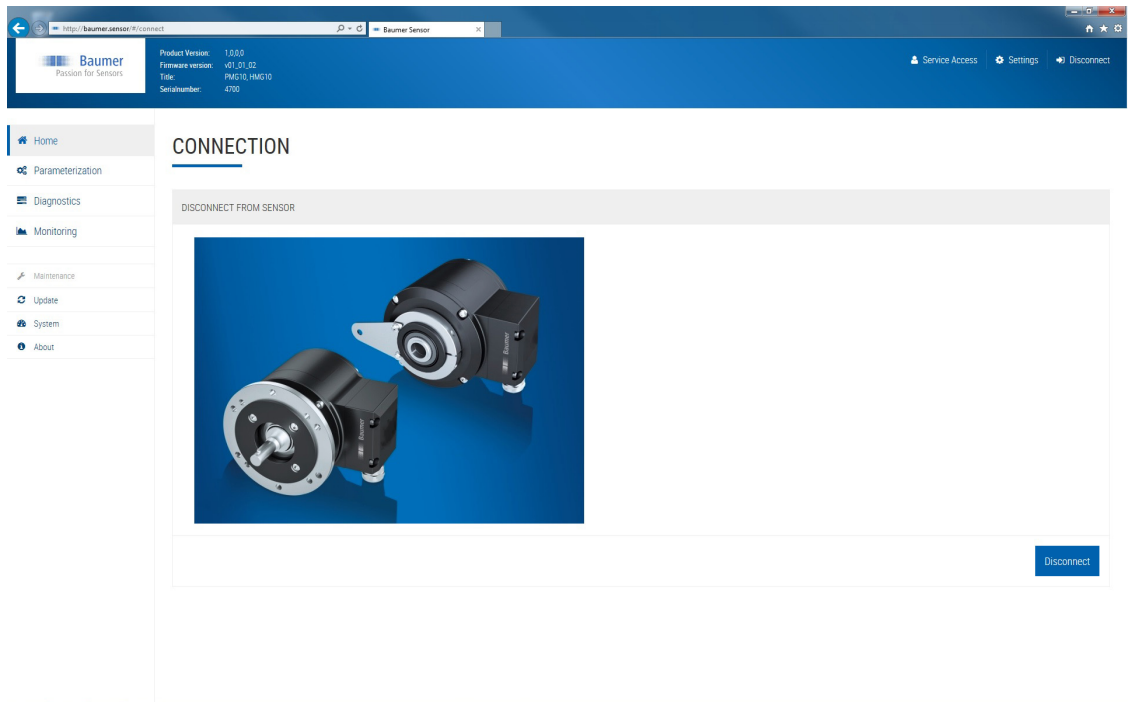

INFO

In the event of extended drops in the mains voltage, the programmer performs restart and the web browser may lose the programmer connection. After one minute, the web browser will recognize the programmer will again. In the next step, data connection can be re-established.

7 Web interface description

7.1 Settings: Language and units

Both language and unit will be adopted from the browser settings and can be changed to **German/English** or **Metric/Imperial**.

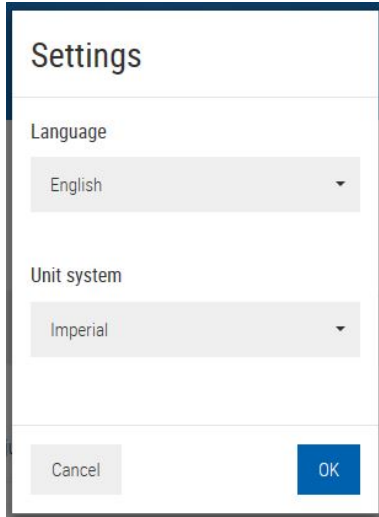

The screenshot shows a 'Settings' window with two dropdown menus. The first is labeled 'Language' and has 'English' selected. The second is labeled 'Unit system' and has 'Imperial' selected. At the bottom, there are two buttons: 'Cancel' and 'OK'.

III. 5: Window settings

7.2 Service access

By default, user logon is **CUSTOMER**. Encoder parameterization requires user logon as **ADMIN**. Doing so requires another password. The ADMIN password of the related encoder can be found on the back of the encoder manual supplied with HMG10P & PMG10P encoders. In case of any questions, please contact your local Baumer Sales team or distributor. Other user names are intended for manufacturers only (e.g. repair or maintenance).

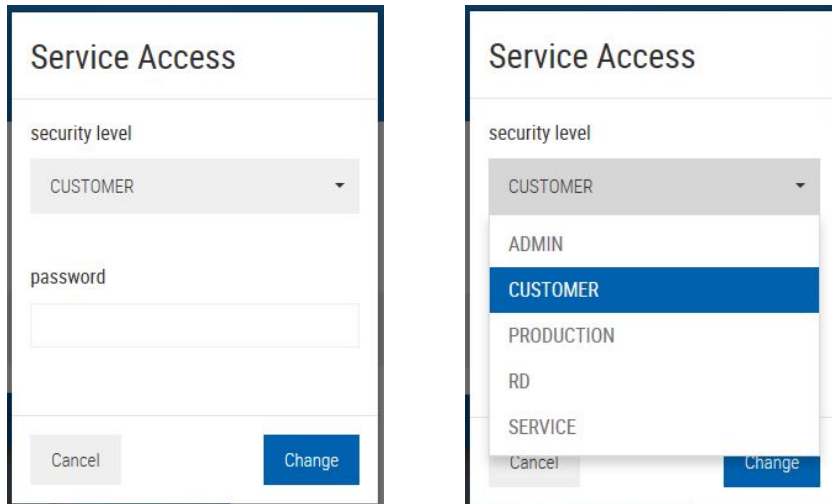

The left screenshot shows the 'Service Access' window with 'security level' set to 'CUSTOMER' and an empty 'password' field. The right screenshot shows the same window with the 'security level' dropdown menu open, displaying options: 'CUSTOMER' (selected), 'ADMIN', 'PRODUCTION', 'RD', and 'SERVICE'. Both screenshots have 'Cancel' and 'Change' buttons at the bottom.

III. 6: The service access window

7.3 System

Window **System** is for system settings of network, WLAN and system status.

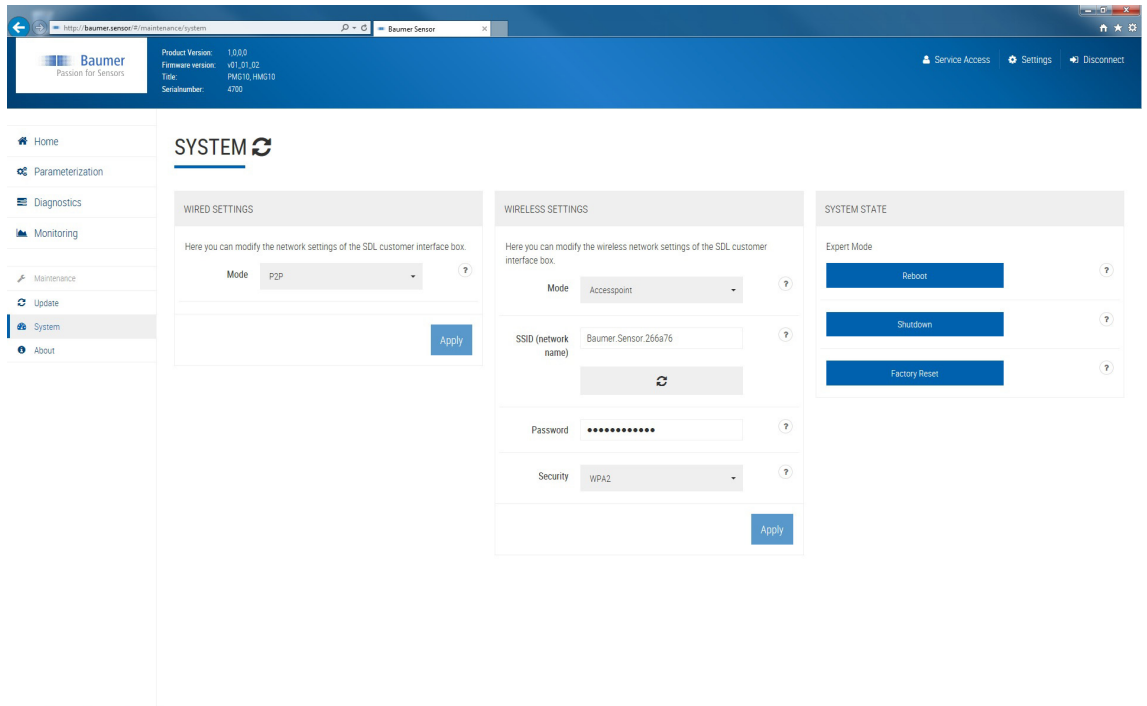

III. 7: System window

7.3.1 Network settings (LAN)

Window **Network settings** is for adjustments in wired network connection. Possible connection options:

- Network cable for direct PC connection (P2P). Here, the programmer acts as a DHCP server.
- Network cable connected to a DHCP server network (Infrastructure or manually). In infrastructure connection, the network acts as a DHCP server, transferring IP address and settings to the programmer. Manual settings are performed in manual connection.



INFO

If the programmer is connected to a DHCP server network, the device for configuration (PC, smartphone, tablet) must be logged on the same network. The switch for wired network mode is used for changing between direct PC connection PC (P2P) and DHC server network connection (Infrastructure/manually).

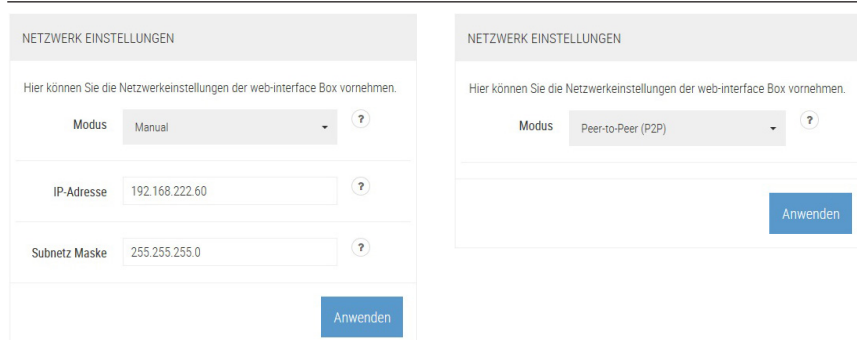

III. 8: Window network settings

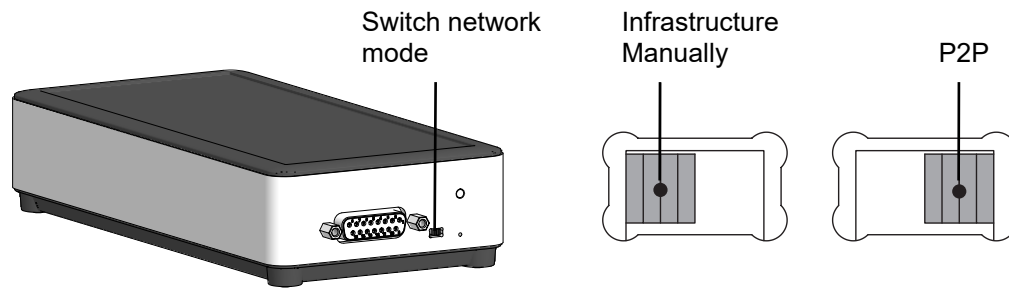

III. 9: Switch network mode

7.3.2 WLAN settings

Window **WLAN settings** is for adjustments in the WLAN connection (mode, SSID, password and security level). Possible connection options:

- Programmer acts as access point.
- Programmer is logged on a network. Here, the WLAN adapter serves as a DHCP server, transferring IP address and settings to the programmer.
- Mode **Off** turns off the WLAN functionality. Now, the programmer can only connect via Ethernet interface.



INFO

If the programmer is logged on a network, the device for configuration (PC, smartphone, tablet) must be logged on the same network.

The screenshot shows the 'WLAN EINSTELLUNGEN' (WLAN Settings) window. It contains the following fields and controls:

- Modus** (Mode): A dropdown menu currently set to 'Accesspoint'.
- SSID (Netzwerk-Name)** (SSID (Network Name)): A text input field containing 'Baumer.Sensor.68e78a'.
- Passwort** (Password): A text input field with masked characters (dots).
- Security** (Security): A dropdown menu currently set to 'WPA2'.
- Anwenden** (Apply): A blue button at the bottom right to save the settings.

III. 10: Window WLAN settings

7.3.3 System control panel

Window **System Control Panel** is for programmer restart or shutdown. Furthermore, it is used to restore default in the programmer.



INFO

Restoring default results in all saved data being lost.

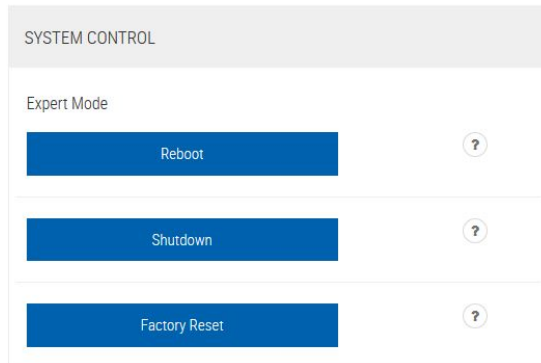

III. 11: Window System Control Panel

7.4 Firmware update

Window **Update** is for updating the programmer firmware. Doing so requires saving the update file on the device used for programmer configuration. Use button **search** to select the file in the local directory system.

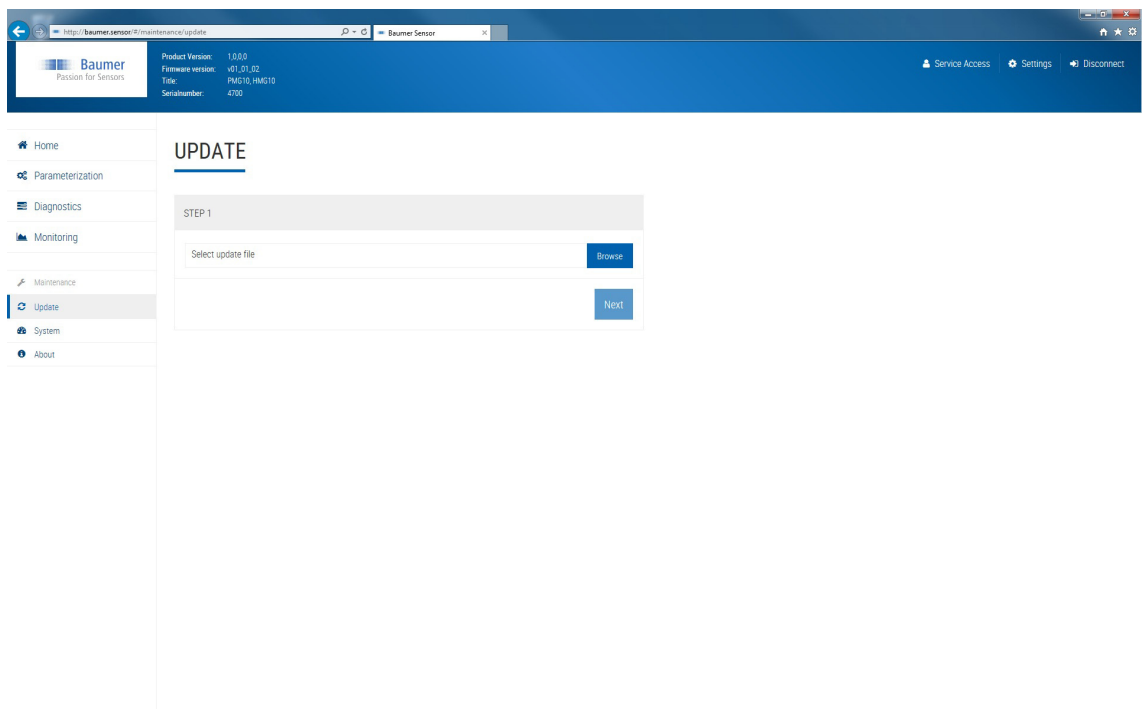

III. 12: Window Update

7.5 Encoder parameters

Window **Parameterization** is for editing encoder parameters. Parameter options:

Incremental parameters: Additional output 1 and 2 (number of pulses per revolution)

SSI Absolute Parameter: Resolution Singleturn (SSI), Resolution Multiturn (SSI), Binary or Gray Code (SSI Speed)

Speed switch: cut-in and cut-off speed, switching hysteresis and switching delay



INFO

Encoder parameterization is password protected and requires **ADMIN** access rights.



INFO

According to the encoder version, not every parameterization option may be available.

III. 13: Window Parameterization

7.6 Parameter Download

Window **Diagnosis** is for encoder parameter download for further processing and documentation.

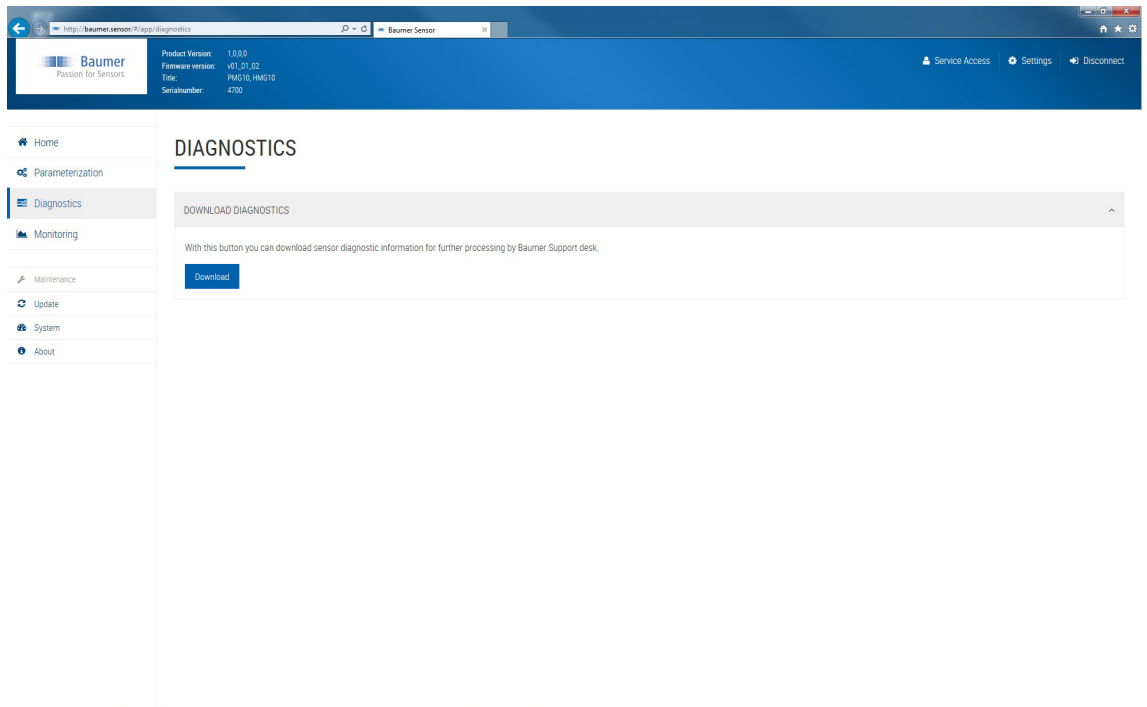

III. 14: Window Diagnosis

7.7 Encoder monitoring

Window **Monitoring** provides encoder position, speed and temperature.

Monitoring does not interact the encoder - controller communication. This means, the encoder signals will be always fully available for controller monitoring. Therefore, monitoring signals are not time-synchronous and can only be used for quality assessments.

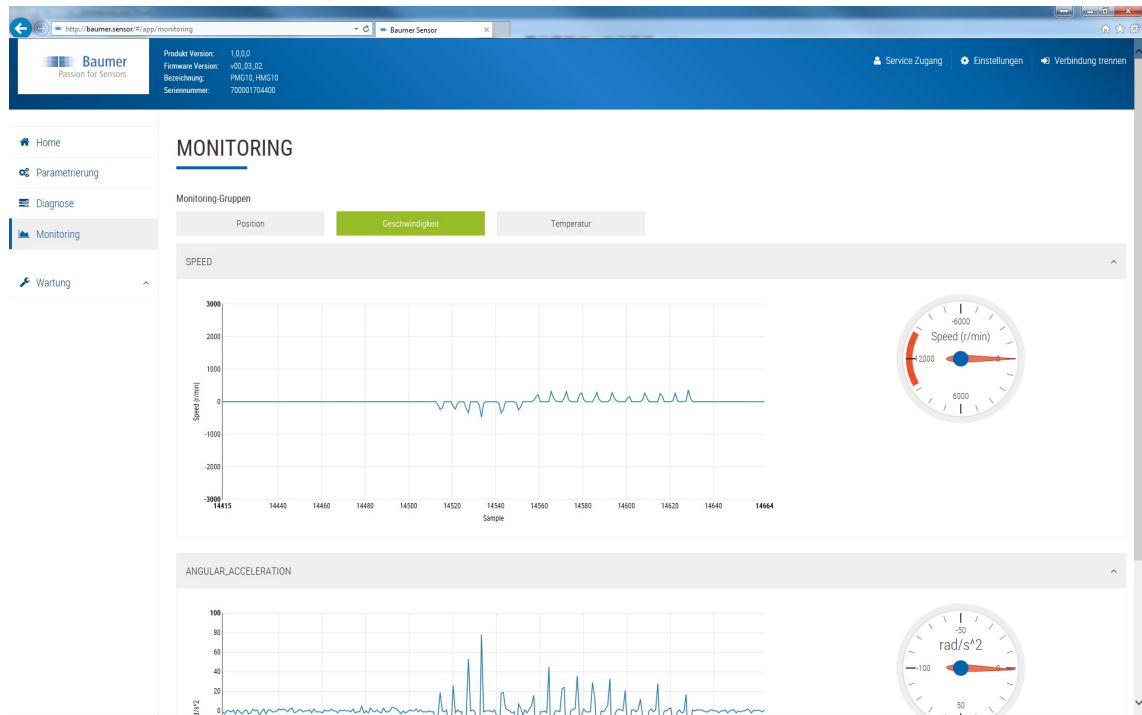

III. 15: Window Monitoring

8 Technical data

Z-PA.SDL.1

Electrical Data

Operating voltage U_b	24 V DC
Encoder supply	5 V DC and 12 V DC via mating 15-contact D-SUB port
Inputs	SSI CLOCK+, SSI CLOCK-, SSI DATA+, SSI DATA-, Analog, RS485-A (SA), RS485-B (SB), INC, C AN HIGH, CAN LOW
Approvals	see data sheet and declaration of conformity

Mechanical

Dimensions W/D/H	180/90/41 mm
Protection class DIN EN 60529	IP20
Connections	Mating 15-contact D-SUB port, 15-pin WLAN - IEEE 802.11 network (WPA2) USB B socket (currently without function) Ethernet port RJ45
Weight approx.	360 g

8.1

Dimensions

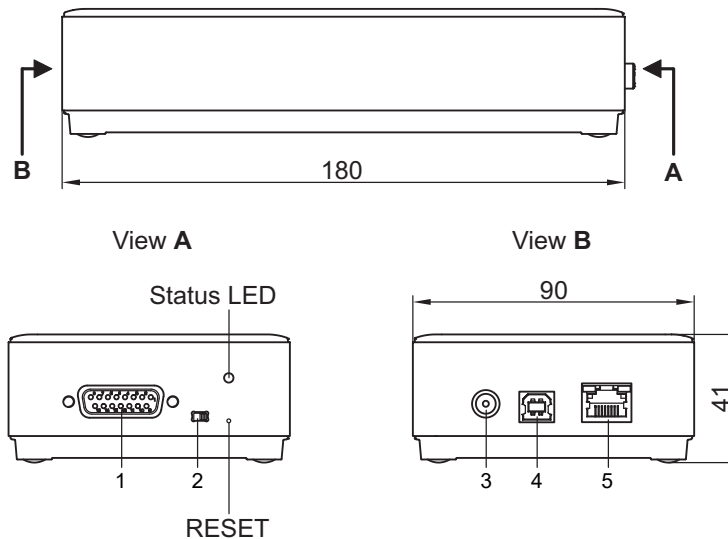

///. 16: WLAN adapter dimensions (in mm, unless otherwise specified)

1	Mating 15-contact D-SUB encoder port	2	Switch network mode
3	Power supply connection	4	USB B port (currently without function)
5	Ethernet port RJ45		

9 Licenses

Baumer uses open source software licensed by copyright holders of free licenses like GNU General Public Licence (GLP Version2, GPL Version3) and GNU Lesser General Public Licence (LGPL), MIT License, zLib License, and licenses derived from the BSD License.

The software is provided for general use, WITHOUT ANY WARRANTY. The present disclaimer includes any implicit assurance of software merchantability or appropriateness for a particular purpose.

For further details please see GNU General Public License. For complete license texts, see baumer.sensor/licences.txt. On request, license texts can be obtained in printed form.

List of illustrations

III. 1	Programmer connection in OFFLINE mode.....	15
III. 2	Programmer connection in ONLINE mode.....	16
III. 3	Switch network mode	17
III. 4	Establishing WLAN connection in the Windows operating system	17
III. 5	Window settings	20
III. 6	The service access window	20
III. 7	System window	21
III. 8	Window network settings	21
III. 9	Switch network mode	22
III. 10	Window WLAN settings.....	22
III. 11	Window System Control Panel.....	23
III. 12	Window Update.....	23
III. 13	Window Parameterization	24
III. 14	Window Diagnosis.....	25
III. 15	Window Monitoring.....	26
III. 16	WLAN adapter dimensions (in mm, unless otherwise specified)	27

90071949328771



Baumer Germany GmbH & Co. KG

Bodenseeallee 7

DE-78333 Stockach

www.baumer.com