

Overview

- Fastest limit value detection due to extremely short response times
- Acquisition of two independent limit values
- Flexible parameterization and additional diagnostic data thanks to IO-Link
- Shortest blind zone in its class
- High performance in compact housing
- Metal connector



Picture similar



Technical data

General data

Scanning range Sd	15 ... 500 mm
Scanning range close limit Sdc	15 ... 500 mm
Scanning range far limit Sde	15 ... 500 mm
Version	IO-Link dual channel Multiplex version
Hysteresis typ.	4 % Sde
Repeat accuracy	0.5 mm
Temperature drift	< 2 % of distance to target Sde
Power-up drift	Compensated after 15 min.
Response time ton/toff min	< 16 ms
Response time ton/toff standard	< 40 ms
Sonic frequency	290 kHz
Adjustment	qTeach, IO-Link
Light indicator	Yellow LED / red LED
Power on indication	LED green
Alignment measuring axis	< 2°

Electrical data

Voltage supply range +Vs	12 ... 30 VDC
Current consumption typ.	16 mA
Output circuit	Push-pull
Output current	<100 mA
Voltage drop Vd	<3 VDC
Residual ripple	< 10 % Vs
Short circuit protection	Yes
Reverse polarity protection	Yes, Vs to GND

Communication interface

Interface	IO-Link V1.1
-----------	--------------

Communication interface

Baud rate	38,4 kBaud (COM 2)
Cycle time	≥ 8 ms
Process data length	48 Bit
Process data structure	Bit 0 = SSC1 (distance) Bit 1 = SSC2 (distance) Bit 2 = quality Bit 3 = alarm Bit 5 = SSC4 (counter) Bit 8-15 = scale factor Bit 16-47 = 32 Bit measurement
IO-Link port type	Class A

Additional data

Distance	Excess gain
Operating cycles	Operating hours
Boot cycles	Operating voltage
Device temperature	Histograms

Adjustable parameters

Switching point	Switching hysteresis
Measured value filtering	Time filters
LED status indicators	Output logic
Output circuit	Counter
Beam forming	Analog output characteristic
Deactivate the sensor element	Find Me function

Mechanical data

Design	Rectangular
Housing material	Plastic (ASA, PMMA)

Technical data

Mechanical data

Width / diameter	20.5 mm
Height / length	41 mm
Depth	15 mm
Connection types	Connector M8 4 pin

Ambient conditions

Operating temperature	-25 ... +65 °C
Storage temperature	-25 ... +75 °C
Protection class	IP 67

Dimension drawing

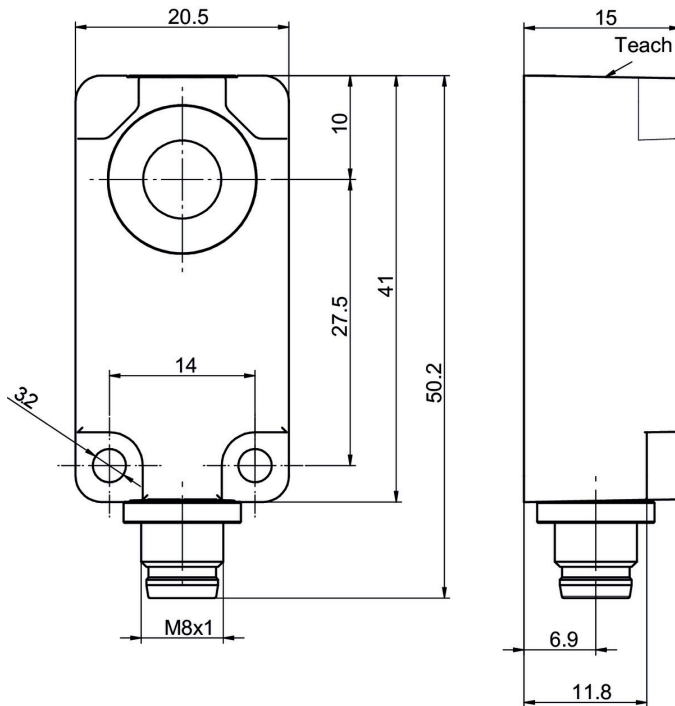

Typical sonic cone profile

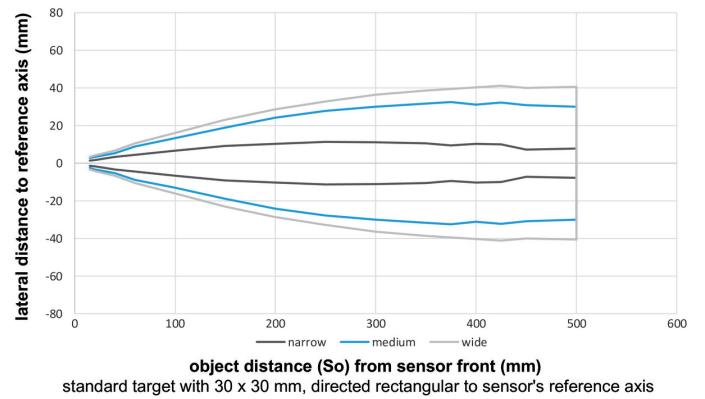

Connection diagram

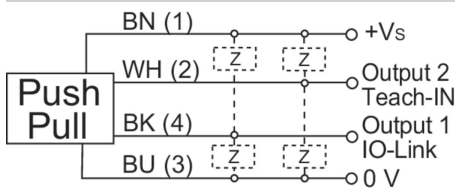

Pin assignment

