



Operating Manual

OX100
Smart Profile sensors

EN-US

List of contents

1	About this document.....	4
1.1	Purpose	4
1.2	Warnings in this manual	4
1.3	Labels in this manual	4
1.4	Liability limitation.....	5
1.5	Scope of delivery	5
1.6	Name plate	6
2	Safety.....	7
2.1	Personnel requirements.....	7
2.2	General information	7
2.3	Laser.....	8
3	Description.....	9
3.1	Sensor	9
3.1.1	Structure	9
3.1.2	Functionality.....	10
3.1.3	Reference surfaces.....	12
3.1.4	Measurement field of the sensor.....	13
3.2	Operating and display elements	15
3.2.1	Web interface.....	15
3.2.2	Sensor LEDs.....	16
3.3	Interfaces and protocols	17
3.3.1	Modbus RTU.....	18
3.3.2	IO-Link	23
3.3.3	External triggering.....	24
4	Transport and storage	25
4.1	Transport	25
4.2	Delivery inspection.....	25
4.3	Storage	25
5	Installation.....	26
5.1	General information for mounting	26
5.2	Mounting the sensor	26
6	Electrical installation.....	27
6.1	General instructions for electric installation	27
6.2	Pin assignment	28
6.3	Connecting the sensor to electricity.....	28
7	Commissioning.....	29
7.1	Connecting the sensor to the PC.....	29
7.1.1	Tracking the sensor's IP address.....	29
7.2	Wiring the sensor.....	30

7.3	Set up RS485 interface with Modbus RTU	31
7.4	IO-Link setup	32
8	Web interface description.....	33
8.1	Functions and tasks	33
8.2	Description of the user interface	33
8.2.1	Header	34
8.2.2	Menu bar	35
8.2.3	Window Measurement Results	36
8.2.4	Footer	36
8.2.5	Visualisation area.....	36
8.2.6	Parametrisation area.....	36
9	Web interface operation.....	37
9.1	Mode Monitoring	37
9.1.1	Saving measured data as a CSV file	38
9.2	Mode Global Parametrization	38
9.2.1	Changing the view	39
9.2.2	Adjusting the internal resolution	43
9.2.3	Optimising the exposure time	44
9.2.4	Adjusting the laser power.....	44
9.2.5	Calculating the surface profile.....	45
9.2.6	Trigger Mode setting	46
9.2.7	Aligning the sensor (height and distance mode).....	47
9.2.8	Mounting Assistant.....	48
9.2.9	Flex Mount: Compensating mounting angles.....	49
9.2.10	Flex Mount: Moving the reference surface.....	52
9.2.11	Resetting Flex Mount	53
9.2.12	Setting the limits of the field of view	53
9.3	Mode Measurement Tools Parametrization.....	54
9.3.1	Setting the position tracking (ROI tracking)	55
9.3.2	Setting the background tracking	56
9.3.3	Temporal Filter setting	57
9.3.4	Processing an invalid measured value	57
9.4	Mode Outputs Parametrization	58
9.4.1	Setting the hysteresis.....	60
9.5	Mode Save Parameter-Setups	62
9.6	Mode Device Configuration	63
10	Preventive maintenance	65
10.1	Cleaning the sensor.....	65
11	Troubleshooting	66
11.1	Resetting the sensor to the factory settings.....	66
11.2	Return and repair	66
11.3	Accessories	66
12	Technical data.....	67
12.1	Dimensional drawing	67

1 About this document

1.1 Purpose

This operating manual (subsequently referred to as *manual*) allows the safe and efficient handling of the product .

The manual does not provide instructions on operating the machine in which the product is integrated. Information on this is found in the operating manual of the machine.

The manual is a constituent part of the product. It must be kept in the immediate vicinity of the product and must be accessible to personnel at all times.



Personnel must have carefully read and understood this manual before beginning any work. The basic prerequisite for safe working is compliance with all safety instructions and handling instructions given in this manual.

In addition, the local occupational health and safety regulations and general safety regulations apply.

The illustrations in this manual are examples only. Deviations are at the discretion of Baumer at all times.

1.2 Warnings in this manual

Warnings draw attention to potential personal injury or material damage. The warnings in this manual indicate different hazard levels:

Symbol	Warning term	Explanation
	DANGER	Indicates imminent danger entailing a high risk of death or serious personal injury if not being avoided.
	WARNING	Indicates a possible danger entailing medium risk of death or (serious) personal injury if not being avoided.
	CAUTION	Indicates a danger with low risk, which could lead to light or medium injury if not avoided.
	NOTE	Indicates a warning of material damage.
	INFO	Indicates practical information and tips that enable optimal use of the devices.

1.3 Labels in this manual

Identifier	Use	Example
Dialog element	Indicates dialog elements.	Click the OK button.
<i>Unique name</i>	Indicates the names of products, files, etc.	<i>Internet Explorer</i> is not supported in any version.
Code	Indicates entries.	Enter the following IP address: 192.168.0.250

1.4 Liability limitation

All information and notes in this manual have been compiled in accordance with the applicable standards and regulations, the state of the art, and our many years of knowledge and experience.

The manufacturer accepts no liability for damage due to the following reasons:

- Non-observance of the manual
- Improper use
- Use of unqualified personnel
- Unauthorized conversions

The obligations agreed in the delivery contract, the general terms and conditions and the delivery conditions of the manufacturer and its suppliers, as well as the legal regulations valid at the time of conclusion of the contract apply.

1.5 Scope of delivery

The scope of delivery includes:

- 1 x sensor
- 1 x quickstart
- 1 x General information leaflet

In addition, you can find the following information, among other things, in digital format at www.baumer.com:

- Operating manual
- Data sheet
- 3D CAD drawing
- Quickstart
- Dimensional drawing
- Connection diagram & pin assignment
- IODD file
- Certificates (EU conformity declaration, etc.)

1.6 Name plate

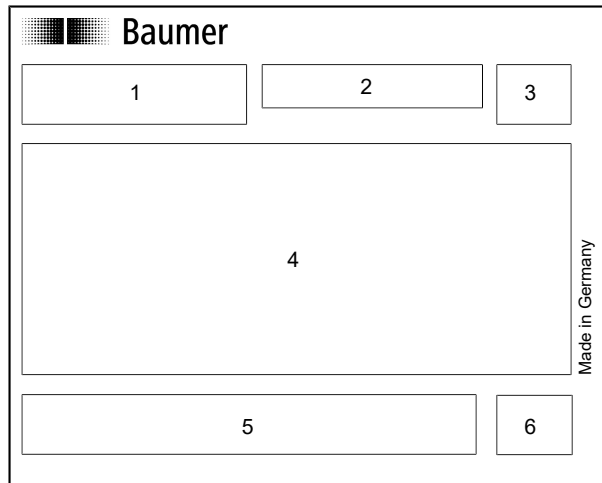

III. 1: Name plate on the sensor

1	Type code, MAC address, serial number	2	Item number, production date
3	Pin pictogram	4	Pin assignment
5	Labels	6	QR code (Baumer website)

2 Safety

2.1 Personnel requirements

Certain work with the product may only be carried out by specialized personnel.

Specialized personnel are staff members who can evaluate the tasks assigned to them and recognize potential danger, based on their training and work as well as a reliable understanding of technical safety issues.

Qualified personnel are divided into the following categories:

- **Instructed personnel:**

A person who has been informed and, if required, trained, by a specialist about the assigned tasks and potential dangers of improper behavior.

- **Specialist:**

A person who, based on his/her training, experience, and instruction, as well as his/her knowledge of applicable standards, rules, and accident prevention regulations, has been authorized to carry out the respectively required tasks, while recognizing and avoiding potential dangers.

- **Electrical specialist:**

A person with the appropriate specialist training, knowledge, and experience allowing him/her to recognize and avoid dangers originating from electricity.

2.2 General information

Intended use

This product is a precision device and serves the detection of items, objects, or physical measurement variables and the preparation or provision of measured values as electric variables for the higher-level system.

Unless specifically labeled, this product may not be used in explosive environments.

Commissioning

Assembly, installation, and calibration of this product may only be performed by a specialist.

Installation

Only use the fasteners and fastener accessories intended for this product for installation. Outputs not in use must not be wired. Unused wires of cable outputs must be insulated. Do not go below the permissible cable bending radii. Disconnect the system from power before the product is electrically connected. Use shielded cables to prevent electro-magnetic interference. If the customer assembles plug connections on shielded cables, then EMC-version plug connections should be used and the cable shield must be connected to the plug housing across a large surface area.

Disposal (environmental protection)



Used electrical and electronic devices may not be disposed of in household waste. The product contains valuable raw materials that can be recycled. Therefore dispose of this product at the appropriate collection point. For additional information visit www.baumer.com.

2.3

Laser



IEC 60825-1/2014
Complies with 21 CFR 1040.10 and
1040.11 except for conformance with
IEC 60825-1 Ed. 3., as described in
Laser Notice No. 56, dated May 8, 2019

3 Description

3.1 Sensor

3.1.1 Structure



III. 2: Structure

1	Electrical connection 12-pin M12, A-encoding, male	2	USB-C connection with blind plug
3	Sensor LEDs	4	Front panel
5	Mounting holes		

3.1.2 Functionality

The sensor measures the surface profile of an object along the projected laser line. Additional sensor functions (tools) enable geometric measurements on the profile of height, width, or edge). These measured values are provided at the integrated process interface, the switching outputs or the analogue output.

Triangulation principle

The sensor works according to the laser triangulation principle:

1. Via a cylindrical lens, a laser beam is expanded to a laser line and projected onto the surface of the measurement object.
2. The measurement object reflects the laser line.
3. The reflected laser line is projected onto a surface camera in the sensor.
4. The sensor uses the camera image and stored calibration data to calculate the profile of a measurement object.

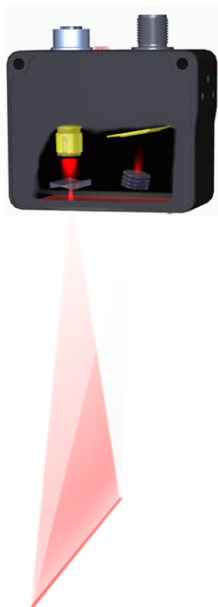

III. 3: Triangulation principle

Sensor functionality

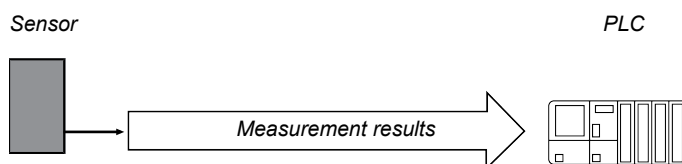

III. 4: Functionality

- The sensor is equipped with smart measurement functions (tools) as well as integrated image processing and delivers precise results in physical units such as mm or degrees.
- Varied measurement functions, such as edge, width, gap.
- Correlation of the measured values, e.g. to calculate the difference between to edges.
- Position tracking of evaluation windows.

Measurement frequency, measurement repeat time and response time

A complete measurement cycle of the sensor consists of the following steps:

1. Exposure and read out
2. Calculation
3. Output of the measured values

Process steps are executed in parallel to increase measuring speed. The illustrations below describe two situations: Measurement rate limited by exposure time (fig.1) and measuring rate limited by calculation time (fig.2):

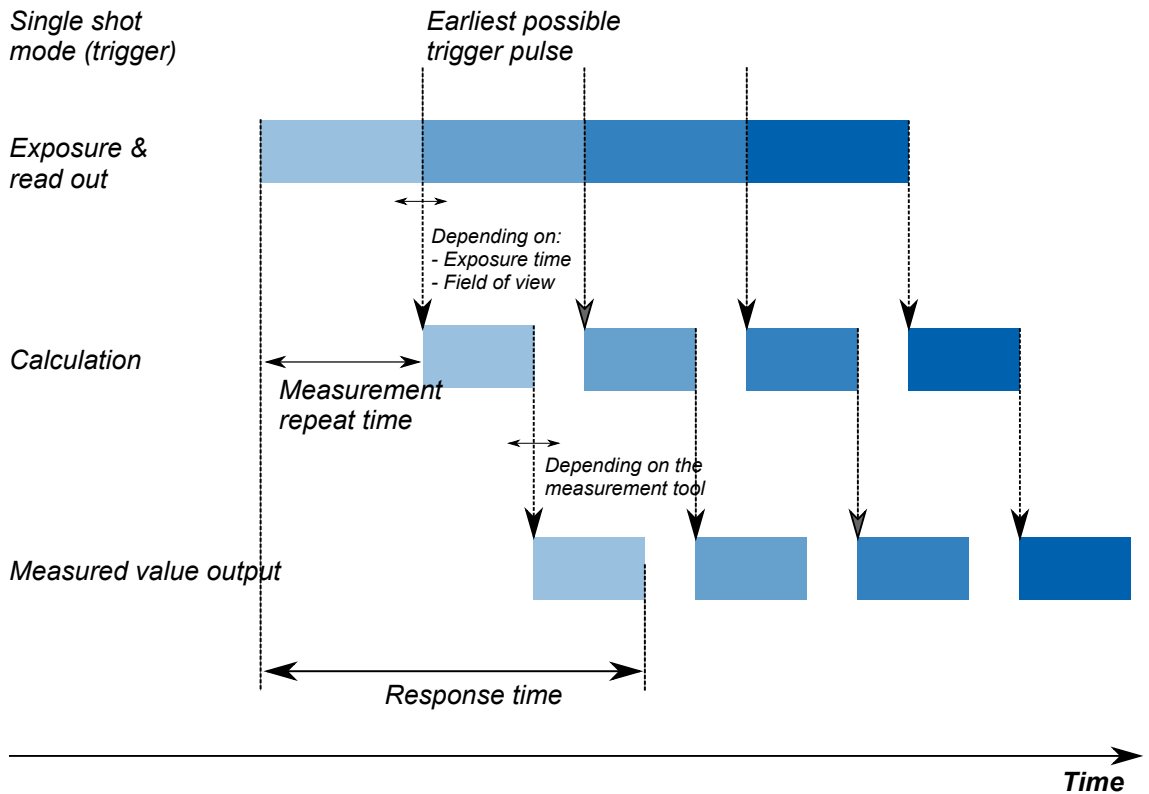

III. 5: Measurement rate limited by exposure time

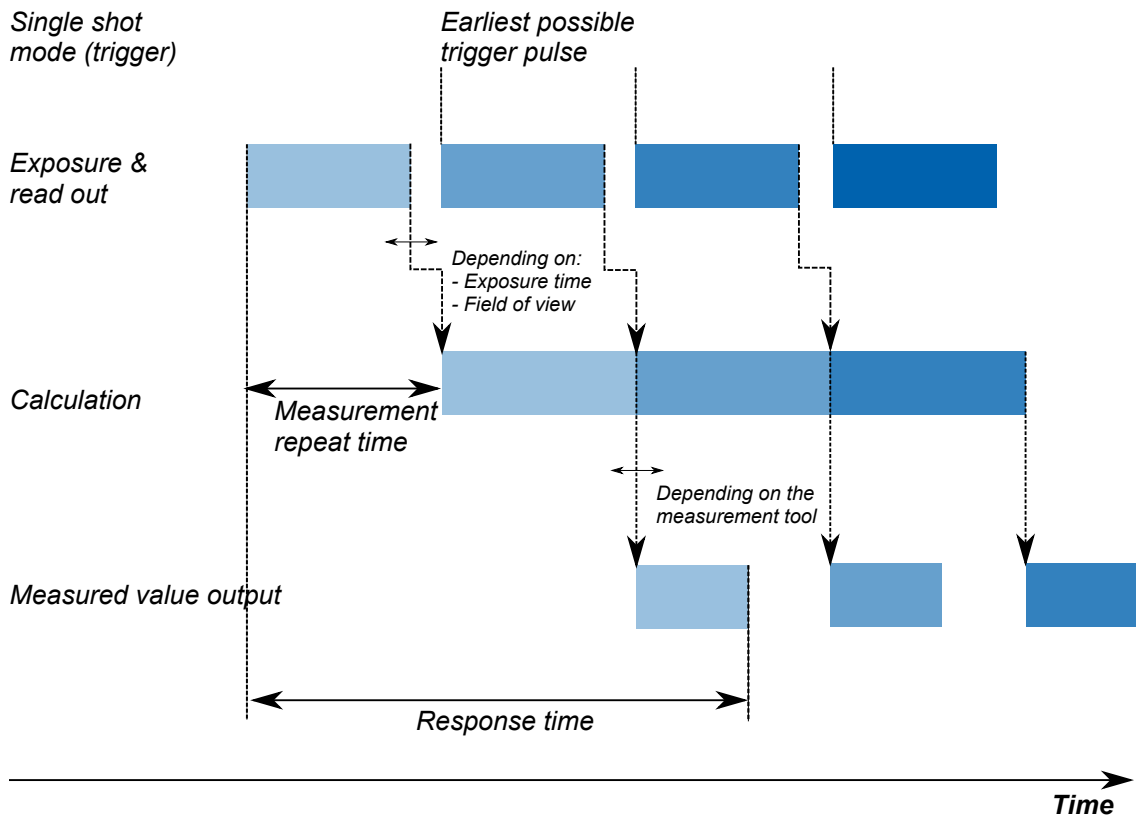

III. 6: Measurement rate limited by calculation time

The time between two exposure periods is called the measurement repeat time, which can be converted into a measurement frequency. The calculated measurement frequency indicates how many measured values the sensor can output per second.

- **Formula for calculating the measurement frequency:**
 - Measurement frequency [kHz] = 1 / Measurement repeat time [ms]

3.1.3 Reference surfaces

The purpose of the reference surfaces R1 to R3 presented below is to facilitate alignment of the sensor during mounting and commissioning.

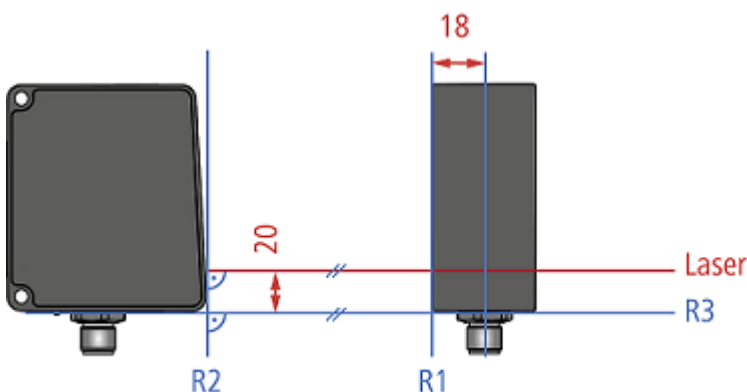

III. 7: Reference surfaces

R1	Reference surface 1; positioned parallel to the side surface at a right angle to the laser beam	R2	Reference level 2; is in a right angle position towards the laser beam
R3	Reference surface 3; extends parallel to the laser beam		

3.1.4 Measurement field of the sensor

The illustration below shows the measurement field of the sensor. The sensor can be operated in both height mode (object space) as well as in distance mode (sensor space), see also [Aligning the sensor \(height and distance mode\)](#) [▶ 47]. Within the blind region (CD), the sensor will not detect any objects.

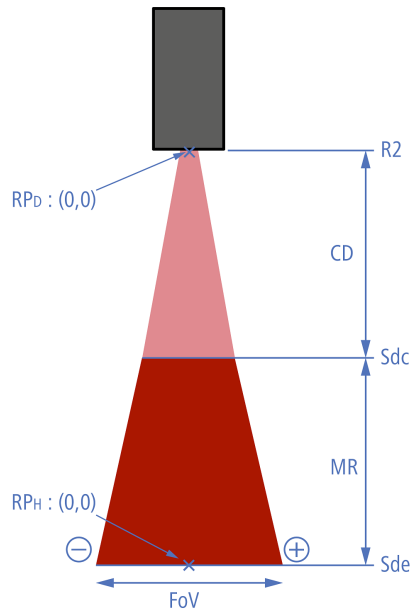

III. 8: Measurement field

RP _D	Zero point in the distance mode	R2	Reference surface 2
RP _H	Zero point in the height mode	MR	Measuring range
CD	Blind region	Sde	End of the measuring range
Sdc	Start of the measuring range	-	Left; area with negative X values
FoV	Field of view width	+	Right; area with positive X values

Transmission and receiving axis

The transmission and receiving axes can lie in the areas shown in blue in the figures below. The exact axes depend on the position of the object. Objects that should not be measured should be kept away from this area as they can interfere with the measurement and lead to incorrect measured values.

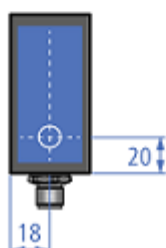
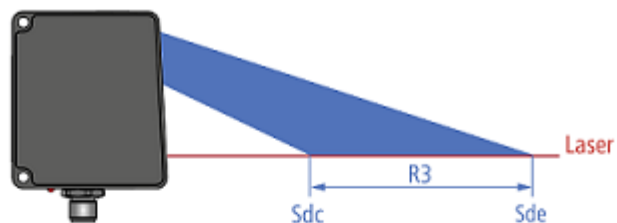

III. 9: Transmission and receiving axis

3.2 Operating and display elements

3.2.1 Web interface

The sensor features a web interface enabling sensor parameterization and data visualization. For doing so, the sensor integrates a web server. Web interface access is via web browser.

For a detailed description of the web interface, the individual elements of the user interface and all required operating processes, see [description web interface \[▶ 33\]](#).

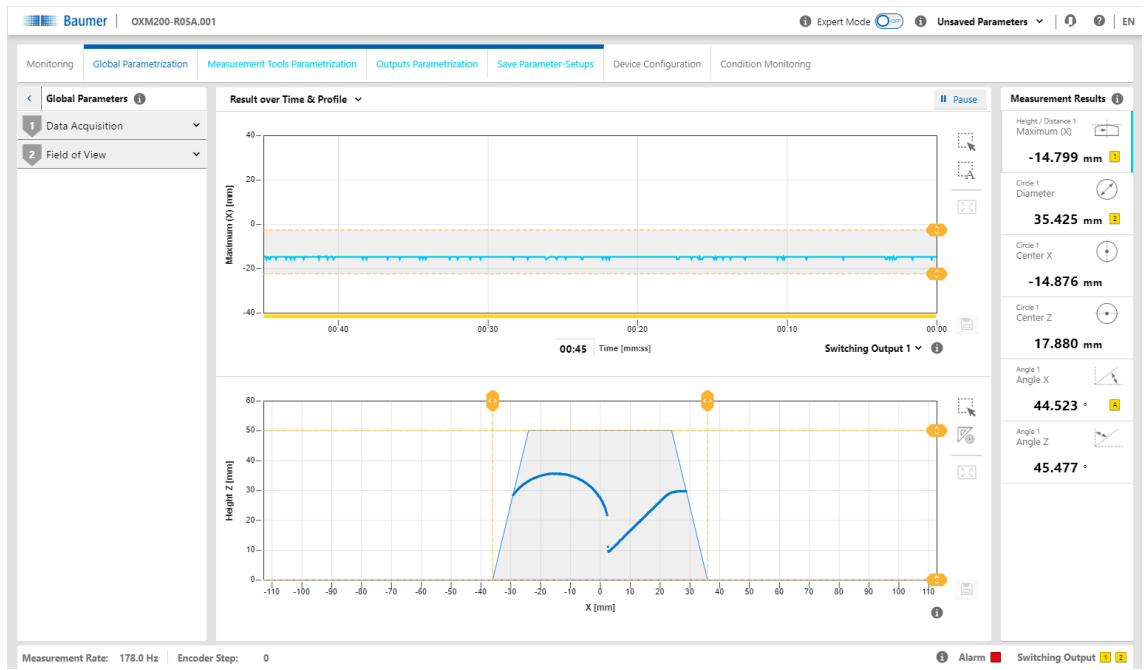

III. 10: Web interface – Overview

3.2.2

Sensor LEDs

Designation		Illuminated	Flashing
OUT 2	Yellow	Switching output 2 active.	Signal reserve of the detected object is close to the detection limit.
OUT 1	Yellow	Switching output 1 active.	Signal reserve of the detected object is close to the detection limit.
ALARM	Red	Sensor starts up. Measured value that is on a switching output is invalid. Sensor is parameterized via a web interface.	Signal reserve of the detected object is close to the detection limit.
POWER LINK	Green	The sensor is ready for operation, but no active USB connection present .As soon as USB connection is active, the LED switches off.	Short circuit at switching output 1 or 2.
	Blue	USB connection active.	Data packets are being received via USB.
	Yellow	-	Modbus package received.
Special modes:			
OUT 1, OUT 2, ALARM, POWER LINK	Yellow, red, violet		All LEDs flash twice, then a longer pause. Indicates a sensor error.

3.3 Interfaces and protocols

The sensor offers a variety of interfaces and protocols (multi-protocol sensor). The available functions and measuring rates depend on the respectively applied protocol.

The sensor supports one client connection per protocol. Read access via the protocols is possible at any time. Write access is only permissible in the parametrisation mode. Only one interface at a time can be in parametrisation mode.

Sensor parameterization and configuration only via the integrated web interface. Read access to the measured values and for changing parameter sets is also enabled via the process interfaces Modbus RTU and IO-Link.

For the precise range of interfaces and protocols, please see the data sheet that is available for download at www.baumer.com/OX100.

3.3.1 Modbus RTU

Modbus RTU is a standardized protocol, here based on a serial client/server communication via RS485. Many PLCs support this protocol already in the state of delivery or allow for retrofit by software module. For PC-based systems, libraries for different programming languages are available. The standard is freely available on the website of the Modbus organisation. Visit <http://www.modbus.org>

For information on Modbus TCP commissioning refer to [Set up RS485 interface with Modbus RTU \[p. 31\]](#).

Mapping the sensor functionality on the Modbus data model

The functionality of the sensor can be accessed by reading or writing entries in the tables **Discrete Inputs**, **Input Registers**, and **holding registers**. The following Modbus function codes (FC) are supported:

- Read Discrete Inputs (FC 02)
- Read Input Registers (FC 04)
- Read Holding Registers (FC 03)
- Write Single Holding Register (FC 06)
- Write Multiple Holding Registers (FC 16)

The following FC tables are independent of each other, so the same address may represent different functions in each table. Basically, Modbus registers are limited to 16 bits. Therefore, when reading or writing larger values, several registers must be taken into account for the respective operation. Reading or writing only part of the specified address is not supported. Less significant words are saved under the inferior address. Example:

- Value (UInt32): 0x12345678
- Register Address n: 0x5678
- Register Address n+1: 0x1234



INFO

1 Modbus register corresponds to 2 bytes. If the data type of a sensor parameter is wider than a 2 byte Modbus register, the parameter is divided among several Modbus registers. The less significant bits are located at the smaller address and the more significant bits at the larger address (Little Endian).

In general, all registers enable write and read. Reading a register with write access only will reply 0xFFFF.

Holding Registers The following table provides an overview of the Index Commands **Holding Registers**. These can be reached with functions 03/06/16.

Address	Data element	Data type	Access	Description
0 (1 Register)	Request parametrisation mode.	UInt16	Write	Request parametrisation mode by writing a random value.
1 (1 Register)	Exit parametrisation mode.	UInt16	Write	Exit active parametrisation mode by writing a random value.
501 (1 Register)	Load parameter setup number.	UInt16	Write	Load a previously parametrised parameter setup.

Input Registers The following tables provide an overview of Index Commands **Input Registers**. These can be reached with function 04.

This function code will read 1 to 125 related input registers in a remote device. The PDU query (**P**rocess **D**ata **U**nit) specifies the start register address and the number of registers. PDU register addressing starts with zero. For this reason, input registers 1-16 are addressed as 0-15.

Address	Data element	Data type	Access	Offset	Description
0 ... 32 (33 Register)	Vendor info	String[65]	Read	0	Manufacturer name

Address	Data element	Data type	Access	Offset	Description
40 ... 88 (49 Register)	Device info		Read		Exit active parametrisation mode by writing a random value.
		String[9]		0 ... 3 4 High byte	Product ID
		String[65]		4 Low byte 5 ... 36	Sensor type
		String[20]		37 ... 46	Serial number
		String[2]		47 ... 48	Padding

Address	Data element	Data type	Access	Offset	Description
200 ... 223 (24 Register)	All Measurement Values (32 Bit)		Read		
	Status	UInt16		0	Status
				Bit 0	Parametrisation mode is active.
				Bit 1	Time is synchronised with NTP server.
				Bit 2	Valid values (measured values allow for interpretation).
				Bit 3	Alarm is active.
	Quality	UInt8		1	Quality information on the current measured values.
				0	OK
				1	Weak signal.
				2	No signal.
	Output	UInt8		2	Outputs
				Bit 0	Status of binary output 1.
				Bit 1	Status of binary output 2.
	Measured value 1	Float32			Measured value parametrised in advance on the web interface.
				3	Low 2 Bytes
				4	High 2 Bytes
	Measured value 2	Float32			Measured value parametrised in advance on the web interface.
				5	Low 2 Bytes
				6	High 2 Bytes
	Measured value 3	Float32			Measured value parametrised in advance on the web interface.
				7	Low 2 Bytes
				8	High 2 Bytes
	Measured value 4	Float32			Measured value parametrised in advance on the web interface.
				9	Low 2 Bytes
				10	High 2 Bytes
	Measured value 5	Float32			Measured value parametrised in advance on the web interface.
				11	Low 2 Bytes
				12	High 2 Bytes
	Measured value 6	Float32			Measured value parametrised in advance on the web interface.
				13	Low 2 Bytes

Address	Data element	Data type	Access	Offset	Description
				14	High 2 Bytes
	Measured value 7	Float32			Measured value parametrised in advance on the web interface.
				15	Low 2 Bytes
				16	High 2 Bytes
	Measurement rate	Float32			Measurement rate
				17	Low 2 Bytes
				18	High 2 Bytes
	Time stamp (s)	UInt32			Value of the time stamp (s) of the most recent measured values.
				19	Low 2 Bytes
				20	High 2 Bytes
	Time stamp (µs)	UInt32			Value of the time stamp (µs) of the most recent measured values.
				21	Low 2 Bytes
				22	High 2 Bytes
		UInt16		23	reserved

Address	Data element	Data type	Access	Offset	Description
401 (1 Register)	Active Parameter Setup Number.	UInt8	Read	0	

Address	Data element	Data type	Access	Offset	Description
2500 ... 2515 (16 Register)	All Measurement Values (16 Bit)		Read		
	Status	UInt16		0	Status
				Bit 0	Parametrisation mode is active.
				Bit 1	Time is synchronised with NTP server.
				Bit 2	Valid values (measured values allow for interpretation).
				Bit 3	Alarm is active.
	Quality	UInt8		1	Quality information on the current measured values.
				0	OK
				1	Weak signal.
				2	No signal.

Address	Data element	Data type	Access	Offset	Description
	Output	UInt8		2	Outputs
					Bit 0 Status of binary output 1.
					Bit 1 Status of binary output 2.
	Measured value 1 ¹	Int16		3	Measured value parametrised in advance on the web interface.
	Measured value 2 ¹	Int16		4	Measured value parametrised in advance on the web interface.
	Measured value 3 ¹	Int16		5	Measured value parametrised in advance on the web interface.
	Measured value 4 ¹	Int16		6	Measured value parametrised in advance on the web interface.
	Measured value 5 ¹	Int16		7	Measured value parametrised in advance on the web interface.
	Measured value 6 ¹	Int16		8	Measured value parametrised in advance on the web interface.
	Measured value 7 ¹	Int16		9	Measured value parametrised in advance on the web interface.
	Measurement rate (Hz) ¹¹	Int16		10	Measurement rate
	Time stamp (s)	UInt32			Value of the time stamp (s) of the most recent measured values.
				11	Low 2 Bytes
				12	High 2 Bytes
	Time stamp (µs)	UInt32			Value of the time stamp (µs) of the most recent measured values.
				13	Low 2 Bytes
				14	High 2 Bytes
		UInt16		15	reserved

¹ Divide the received measured value by 100 to obtain the result in the physical measuring unit.

¹¹ Divide the received measuring rate by 10 to obtain the measuring rate in Hz.

3.3.2 IO-Link

The sensor supports IO-Link communication for transfer of cyclic process data and status information. The device supports COM 3 transmission rate in line with IO-Link specification.

You can either use the setup parameters stored in the sensor or the web interface-programmed setup parameters (see [Mode Save Parameter-Setups \[▶ 62\]](#)). Further parametrisation of measurement-relevant parameters via IO-Link is not possible. The order of the measured results is defined by the order specified in the web interface (see [Mode Measurement Tools Parametrization \[▶ 54\]](#)).

Cyclic/acyclic data

During data transfer, a distinction is made between cyclic data and acyclic data:

- **Cyclic data:** The measured values 1 to 5 parameterized via the web interface, the encoder position (if encoder input present) and the following binary signals will be transferred as cyclical data:
 - Alarm output
 - Quality bit (signals a weak signal)
 - Switching states of the switching outputs
 - Status information whether the sensor is currently in the parametrisation mode.
 - Information whether the time has been synchronised.
- **Acyclic data:** The measured values 1 to 7 parameterized via the web interface, the sensor's measurement rate and all other available information (see IODD file) are transferred as acyclic data.

3.3.3 External triggering

With external triggering, the sensor waits for an external signal, which can also be fed in via specific inputs (see also [Pin assignment \[▶ 28\]](#)).

Single-shot measurement

In Single Shot mode, the sensor records exactly one measured value as soon as it is triggered by an external pulse. The recorded measured value is maintained at all outputs. For the specification of input *IN 1 (sync in)*, please see the data sheet that is available for download at www.baumer.com/OX100. The delay between the detection of a trigger and the start of a measurement is $< 25 \mu\text{s}$.

- The sensor checks the *IN 1 (sync in)* input before each measurement.
- As soon as the sensor detects a falling edge (transition from high to low level) on input *IN 1 (sync in)*, a measurement is triggered.
- The previous measuring cycle is always completed first, even if input *IN 1 (sync in)* is set to high.
- The power of the laser beam is reduced during the waiting time (Hold).
- As soon as input *IN 1 (sync in)* is set to high, all output functions are frozen in their last state until the next measurement.
- Input *IN 1 (sync in)* must be at least $25 \mu\text{s}$ at the low level before the sensor starts measuring again.
- When the *IN 1 (sync in)* pulse is ideally timed in relation to the exposure time, a fast measuring rate can be achieved that is comparable to the one in free running mode.

Example: Reciprocal influence

If the laser line of sensor 2 lies in the measurement field of sensor 1, the sensors may interfere with each other. If this interference cannot be prevented by suitable mounting, the sensors can be operated asynchronously using the *IN 1 (sync in)* input and Single Shot trigger mode. A higher-level controller must generate the signals for this. For more information, see [Trigger Mode setting \[▶ 46\]](#).

4 Transport and storage

4.1 Transport

NOTICE

Material damage due to improper transport.

- a) Ensure maximum diligence when unloading the delivered packages as well as when transporting them inside the company.
- b) Note the information and symbols on the packaging.
- c) Only remove packaging immediately before mounting.

4.2 Delivery inspection

Upon receipt immediately inspect the delivery for completeness and transport damage.

Claim any defect as soon as it is detected. Damages can only be claimed within the applicable claims deadlines.

In case of externally visible transport damage, proceed as follows:

Instruction:

- a) Do not accept the delivery or only with reservations.
- b) Note the scope of the damage on the transport documents or the delivery slip of the carrier.
- c) Initiate the claim.

4.3 Storage

Store the product at the following conditions:

- Only transport or store the device in its original packaging.
- Do not store outdoors.
- Store dry and free from dust.
- Do not expose to aggressive media.
- Keep away from the sun.
- Avoid mechanical agitation.
- Storage temperature: -10 ... +60 °C.
- Ambient humidity: 20 ... 85 %
- When storing for longer than 3 months, regularly check the general state of all parts and the packaging.

5 Installation

5.1 General information for mounting

- Recommended installation: The sensor's reference level R2 aligned in parallel towards the surface to be measured
- If required, the optimal alignment of the sensor can be graphically supported by the mounting assistant in the web interface.
- Angled mounting within a max. 30° angle (between the sensor's reference level R1 versus the surface to be measured). For doing so, activate in mode **Parametrization | Global Parametrization | Field of View** function **Flex Mount** (see [Flex Mount: Compensating mounting angles](#) ▶ 49).
- Objects suitable for measurements using the light-section technology have a bright, diffuse and reflecting surface, for example, matt white or grey. A glossy surface can result in unstable and/or imprecise measured values, depending on angle and degree of reflection.
- To eliminate any measuring errors by scattered light, the background should be dark, e.g. a matt black.
- Power supply is via the electrical connection (12-pin M12 connector, A-encoding, male).
- The USB interface is only intended for data transfer. Power supply is always via the 12-pin M12 connector.

5.2 Mounting the sensor

Condition:

- ⇒ Screws M4×40 (2).
- ⇒ Matching washers (preferably toothed to penetrate the anodized layer of the sensor housing).

Instruction:

- ◆ Screw the sensor in place.
Torque: max. 1.2 Nm.

6 Electrical installation

6.1 General instructions for electric installation

NOTICE

Device damage due to faulty power supply.

The device can be damaged due to faulty power supply.

- a) Operate the device only with protected low voltage and safe electrical isolation of protection class III.

NOTICE

Device damage or unintended operation due to work on live parts.

Any wiring work on live parts may lead to unintentional operation.

- a) Prior to performing any wiring work disconnect power supply.
- b) Only connect or disconnect any terminals when not live.

NOTICE

IP65 protection is no longer present after removing the protective plug.

Remove the protective plug for the shortest time possible and only in a clean ambience.

- The sensor's USB port is only for temporary data transmission, e.g. parameterization or trouble shooting. It is not intended as host interface for permanent use at the installation in industrial environments. Power supply always via the 12-pin M12 connector.
- Prerequisites for IP rating:
 - Cable connection present at the process interface (12-pin M12 connector).
 - The USB port must be sealed (black cap) during operation. When putting on the black cap, make sure it is free from soiling (dust or liquids).

6.2 Pin assignment



INFO

The pin assignment described below is a maximum configuration. For the precise pin assignment of your sensor, please see the data sheet that is available for download at www.baumer.com.

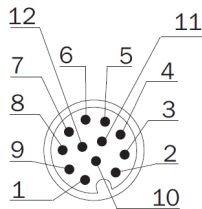

1	Power (18 ... 30 VDC) / IO-Link P24 (2L+)	2	GND / IO-Link N24 (2M)
3	n. c.	4	Analog Out
5	n. c.	6	OUT 1 / IO-Link C/Q
7	RS485 / TX/RX+	8	OUT 2
9	IN 1 (sync in)	10	RS485 / TX/RX-
11	Power / IO-Link L+	12	GND / IO-Link L-

Pin 11 and pin 12 must be assigned even if not using IO-Link but *OUT 1*.

Wire colors according to DIN IEC 757

1	BN – Brown	2	BU – Blue
3	WH – White	4	GN – Green
5	PK – Pink	6	YE – Yellow
7	BK – Black	8	GY – Grey
9	RD – Red	10	VT – Violet
11	GY-PK – Grey Pink	12	RD-BU – Red Blue

6.3 Connecting the sensor to electricity

NOTICE

Use a power unit for sensor supply. The USB interface is intended for data transfer only. Power supply is always via the 12-pin M12 connector.

Instruction:

- Ensure that the system is disconnected from power.
- Connect the sensor according to the pin assignment.

7 Commissioning

7.1 Connecting the sensor to the PC

Condition:

- ⇒ PC with web browser *Mozilla Firefox* from version 69 or *Google Chrome* from version 77.
- ⇒ The sensor's part number code (product identification) must be available. The part number code can be found on the sensor's silver label.

Instruction:

- a) Connect sensor to a PC via a USB C cable.
- b) Open the web browser on your PC.
- c) In the URL address line, enter the part of the product code before the "hyphen".
Example: For the product with part number code *OXM100-R05V.001* enter `http://OXM100.local`.

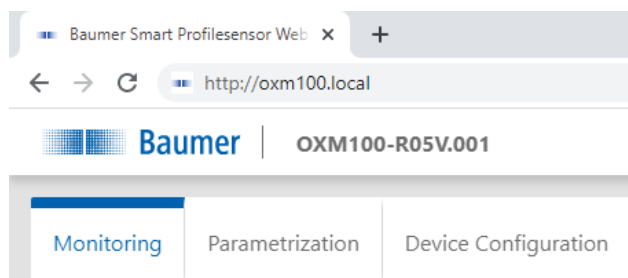

7.1.1 Tracking the sensor's IP address

Below is a description of how to identify the sensor's IP address. This is required if the IP address was assigned via DHCP or the statically set IP address is no longer available. In general, there are 2 options for identifying the IP address.

Option 1: IP address query via mDNS

Instruction:

- a) Open a browser.
- b) Enter the following command in the browser's URL line:
`OXM100-[identifier].local`
Replace `[identifier]` by the eight-digit product number or with the MAC address provided on the sensor.
Replace `OXM100` with the part of the sensor product code before the hyphen "-".
Both are found on the silver label of the sensor.
Example: `OXM200-11218413.local` or `OXM200-11-22-33-44-55-66.local`

NOTICE! Inf only one sensor is active in the network or connected to your PC you may omit the identification. In this case, the sensor is accessible under `OXM100.local`.

Result:

- ✓ The device opens the web interface.

Option 2: IP address query via ping command

- a) In Windows, select **Start | Search**.
- b) In the search bar, enter the value `cmd`.
✓ The **Prompt** window opens.

c) Enter the following command: `ping OXM100-[identifier].local`

Replace `[identifier]` with the eight-digit article number or with the MAC address stated on the sensor.

Replace `OXM100` with the part of the sensor denomination before the `-`.

Both are found on the silver label of the sensor.

Example: `ping OXM100-11218413.local` or

`ping OXM100-11-22-33-44-55-66.local`

Result:

- ✓ The IP address of the sensor is displayed (in the example: `192.168.0.250`):
"Pinging OXM100-12345678.local [192.168.0.250] with 32 bytes of data"

The sensor might not be accessible by PC though having entered the sensor's IP address. In this case, allocate a new IP address to your PC. Make sure to allocate your PC an IP address that is close to the sensor's IP address, e.g.:

- IP address of PC: `192.168.0.251`
- IP address of sensor: `192.168.0.250`

7.2 Wiring the sensor

Observe the general rules for wiring.

- The maximum cable length is 20 m.
- Use shielded cables for data transfer.
- In cable assembly ensure the cable shield being properly connected to the connector housing.

7.3 Set up RS485 interface with Modbus RTU

The sensor supports Modbus RTU and ASCII via RS485 for retrieving measured values and for parameterization.

Communication via the RS485 interface is a serial master-slave communication, reason why the serial communication parameters must first be known for all users:

- Slave address: 1
- Data bits: 8
- Number of stop bits: 1 bit
- Parity: even
- Baud rate (bps): 19200 (default), to be optionally changed via the web interface

Example: Reading out measured values

Instruction:

- a) Stellen Sie die Kommunikationsparameter (s. o.) am Master ein.
- b) Read the input register.
 - Function ID: 04
 - Address 200: All Measurement values (see chapter [Modbus RTU \[▶ 18\]](#))
 - Number of registers: 24

Result:

- ✓ You receive the response telegram of the structure described in chapter [Modbus RTU \[▶ 18\]](#).



INFO

1 Modbus register corresponds to 2 bytes. If the data type of a sensor parameter is wider than a 2 byte Modbus register, the parameter is divided among several Modbus registers. The less significant bits are located at the smaller address and the more significant bits at the larger address (Little Endian).

7.4 IO-Link setup

Download IODD file for the sensor at www.baumer.com/OX200 or at *IODDfinder* (<https://ioddfinder.io-link.com>). You can track the matching IODD file using the sensor's product number.

The sensor requires an IO-Link master of port class B (additional power supply via pin 11 and pin 12). If the IO-Link master supplies sufficient current, the sensor can also be operated in a port class A configuration. Pin 11 must also be connected to voltage for this purpose.

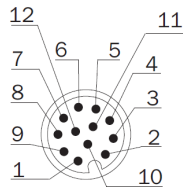

1	Power (18 ... 30 VDC) / IO-Link P24 (2L+)	2	GND / IO-Link N24 (2M)
3	n. c.	4	Analog Out
5	n. c.	6	OUT 1 / IO-Link C/Q
7	RS485 / TX/RX+	8	OUT 2
9	IN 1 (sync in)	10	RS485 / TX/RX-
11	Power / IO-Link L+	12	GND /IO-Link L-

For more information about the IO-Link interface, see [IO-Link ▶ 23](#).

8 Web interface description

8.1 Functions and tasks

The web interface offers users the option of configuring the sensor in a simple yet precise way. The web interface can be used for the configuration of sensor parameters as well as parametrisation of the application-specific measuring tasks. The web interface allows you to visualise what the sensor "sees", so you can use this information to precisely adjust the sensor to the given conditions.

8.2 Description of the user interface

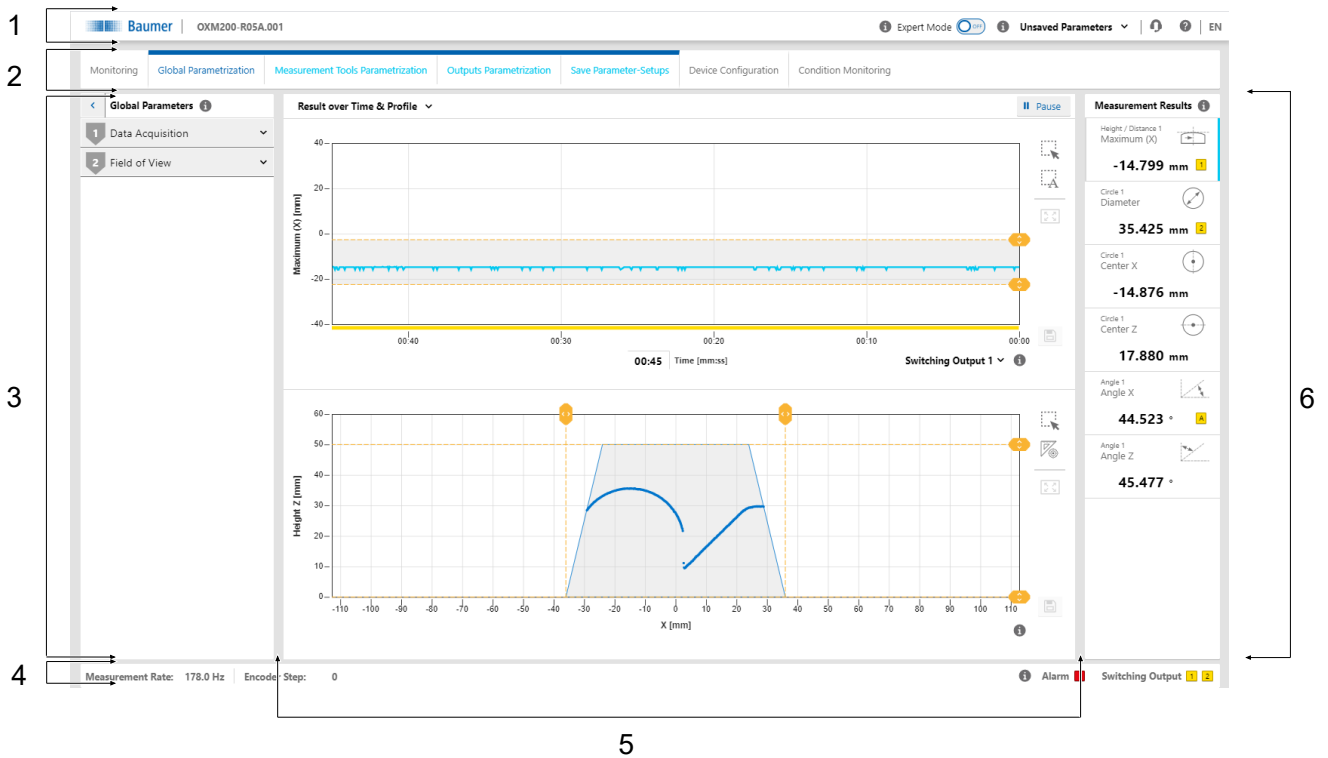



III. 11: Web interface – user interface

1	Header area	2	Menu bar
3	Parametrisation area	4	Footer area
5	Visualisation area	6	Measurement Results window

8.2.1 Header

The header is found in the top section of the user interface. The header is always visible, no matter which mode is currently applied.

Example: <i>OXM200-R05A.001</i>	<ul style="list-style-type: none"> ▪ Sensor name (part number code)
<i>Expert Mode</i>	<ul style="list-style-type: none"> ▪ Activation/deactivation of the expert mode. ▪ In the expert mode, more complex functions and parameters become visible that require a deeper understanding of measurement physics and the applied algorithm. The expert mode can be activated and deactivated at any time.
	<ul style="list-style-type: none"> ▪ Call up the context help.
<i>Parameter Setup</i>	<ul style="list-style-type: none"> ▪ Select the desired parameter setup. ▪ Changes take effect immediately. However, the changes must be stored in the parameter setup to be available after a restart of the sensor.
<i>Unsaved Parameters</i>	<ul style="list-style-type: none"> ▪ Message that a change has not been stored yet.
	<ul style="list-style-type: none"> ▪ Button for requesting support via e-mail. ▪ Display of sensor type and serial number.
	<ul style="list-style-type: none"> ▪ Link to the Baumer website.
<i>EN</i>	<ul style="list-style-type: none"> ▪ Selection of the language of the user interface.

8.2.2 Menu bar

The menu bar allows the navigation among the modes of the web interface. The currently selected menu item is highlighted by a blue ribbon and blue text.

Monitoring	<ul style="list-style-type: none"> ■ Display of measured data. ■ No parameter change enabled.
Parametrization	<ul style="list-style-type: none"> ■ Sensor parameterization. ■ Access to this mode may protected by password as an option. ■ In parameterization mode, the alarm output is set to high.
– Global Parametrization	<ul style="list-style-type: none"> ■ Initial settings of the signal chain (particularly camera): <ul style="list-style-type: none"> ▪ Optimisation of data collection. ▪ Optimisation of the field of view.
– Measurement Tools Parametrization	<ul style="list-style-type: none"> ■ Selection and setup of the smart functions integrated into the sensor.
– Outputs Parametrization	<ul style="list-style-type: none"> ■ Allocation of the measured values to the switching outputs. ■ Setting the switching windows and switching points.
– Save Parameter-Setups	<ul style="list-style-type: none"> ■ Storage of the the set parameters as a parameter setup in the sensor (maximum 32 setups) or externally. ■ External storage is in the .json format. The JSON file can be transferred to sensors with identical type code (measurement range and interface). ■ The parameter setups can each be renamed separately as well as imported/exported. ■ Alternatively, you can import/export the entire parameter setup. ■ A single file contains all sensor parameters except the interface-relevant parameter. ■ Interface-relevant parameters are also saved when saving the entire parameter setup block. When importing, you can select whether these are imported.
Device Configuration	<ul style="list-style-type: none"> ■ Setting the interface-specific properties (Ethernet configuration, active process interfaces).
Condition Monitoring	<ul style="list-style-type: none"> ■ Display of diagnostic data, such as operating time, temperature and operating voltage.

8.2.3 Window Measurement Results

The parameterized measured values appear in window **Measurement Results**. Display layout depends on the sensor-configured measurement tools. First, the window is empty but it allows for display of up to 7 measured values. Clicking one of the fields provides the assigned measured value in the visualisation area. The current selection is visualized by a blue line or by being indented. In the webinterface, the measured values come in the order they are transmitted via the process interfaces.

A	<ul style="list-style-type: none"> A yellow symbol indicates whether the measured value is assigned to one of the switching outputs or the analogue output. The colour of the symbol does not change regardless whether the switching output is active or not.
1	
2	<ul style="list-style-type: none"> See also Mode Outputs Parametrization [▶ 58].

8.2.4 Footer

The footer is found at the bottom of the user interface. The footer is always visible, no matter of the currently applied mode.

Measurement Rate	<ul style="list-style-type: none"> Display of the current measurement rate (in Hz).
Alarm	<ul style="list-style-type: none"> Status of the alarm output: <ul style="list-style-type: none"> Red: Alarm output is active.
Switching Output	<ul style="list-style-type: none"> Status of the switching output: <ul style="list-style-type: none"> Yellow: switching output active. Grey: switching output inactive.

8.2.5 Visualisation area

The measured data is displayed in the visualisation area. The style and structure of the visualisation area depend on the currently active mode of the web interface.

8.2.6 Parametrisation area

In the parametrisation area, depending on the selected menu item within the **Parametrization** mode, you can set various parameters (see [Mode Global Parametrization](#) [▶ 38], [Mode Measurement Tools Parametrization](#) [▶ 54], [Mode Outputs Parametrization](#) [▶ 58] and [Mode Save Parameter-Setups](#) [▶ 62]).

9 Web interface operation

9.1 Mode Monitoring

In **Monitoring** mode, the time curve of the measured value selected in the **Measurement Results** window (see [Window Measurement Results](#) [36]) is displayed in the visualisation area. In addition, there are various setting options for the display of the measured values. The grey background and the dotted orange lines indicate the switching output window or the switching point.

In **Monitoring** mode, no parameters can be changed.

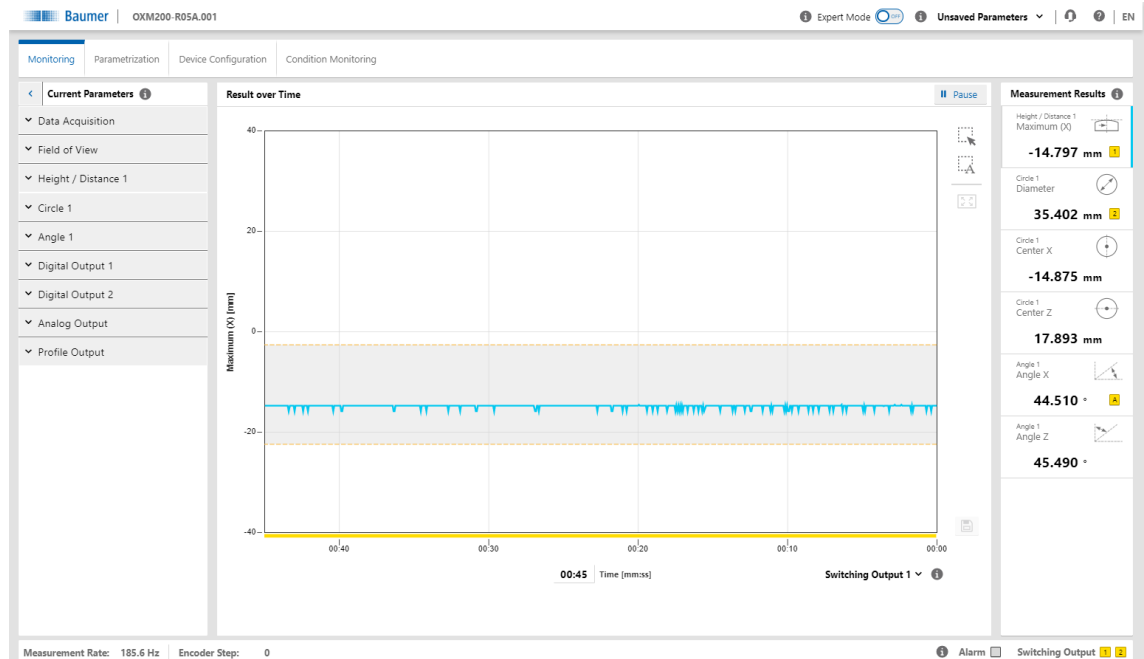

III. 12: Web interface – Monitoring mode

II Pause



- Visualisation is stopped.
- Scaling of the measured value display by expanding the view.



- Automatic, dynamic scaling of the measured value display depending on the displayed data.



- Reset scaling.



- Save measured values as a CSV file.

Signal

- Selection of the signal quality and the visualised switching states via a drop-down list:
 - **Signal quality:**
 - Green: valid signal
 - Yellow: weak signal
 - Red: no signal (no valid measured value)
 - **Switching output:**
 - Yellow: switching output is active
 - Grey: switching output is inactive

Time [mm:ss]

- Setting the time period in which the measured values are displayed (can be freely selected). The set time period applies to all defined measured values.

9.1.1 Saving measured data as a CSV file

The web interface offers you the option of saving the displayed measured data as a CSV file. The CSV file stores the time curve of the measured data, the status of the signal quality and the status of the switching outputs.

To save the measured data as a CSV file, proceed as follows:

Instruction:

- a) In the visualisation area click the button **II Pause**.
 - ✓ The currently displayed measured data are frozen.
- b) Click the diskette symbol in the visualisation area.
- c) The file is saved in the .csv format.

9.2 Mode Global Parametrization

In **Global Parametrization** mode, you can carry out settings at the beginning of the signal chain (especially camera).



III. 13: Web interface – Global Parametrization mode

- Result over Time & Profile**
- Selection of the view of the measured values in the visualisation area.
 - You have a choice of 5 views (for details see [Changing the view \[▶ 39\]](#)):
 - **Result over Time & Profile**
 - **Profile & Camera Picture**
 - **Intensity & Camera Picture**
 - **Profile & Intensity**
 - **Profile**

- Show Tool values**
- Visualisation of all set measured values.

9.2.1 Changing the view

You have a choice of 5 different views for display of the measured values in the visualisation area (in **Parametrization** mode). The views offer you the information required for parametrization of the respective situation. To change the view in the visualisation area, proceed as follows:

Instruction:

- ◆ Select the desired view in the drop-down menu on the top left of the visualisation area.

You can choose from the following views:

Result over Time & Profile

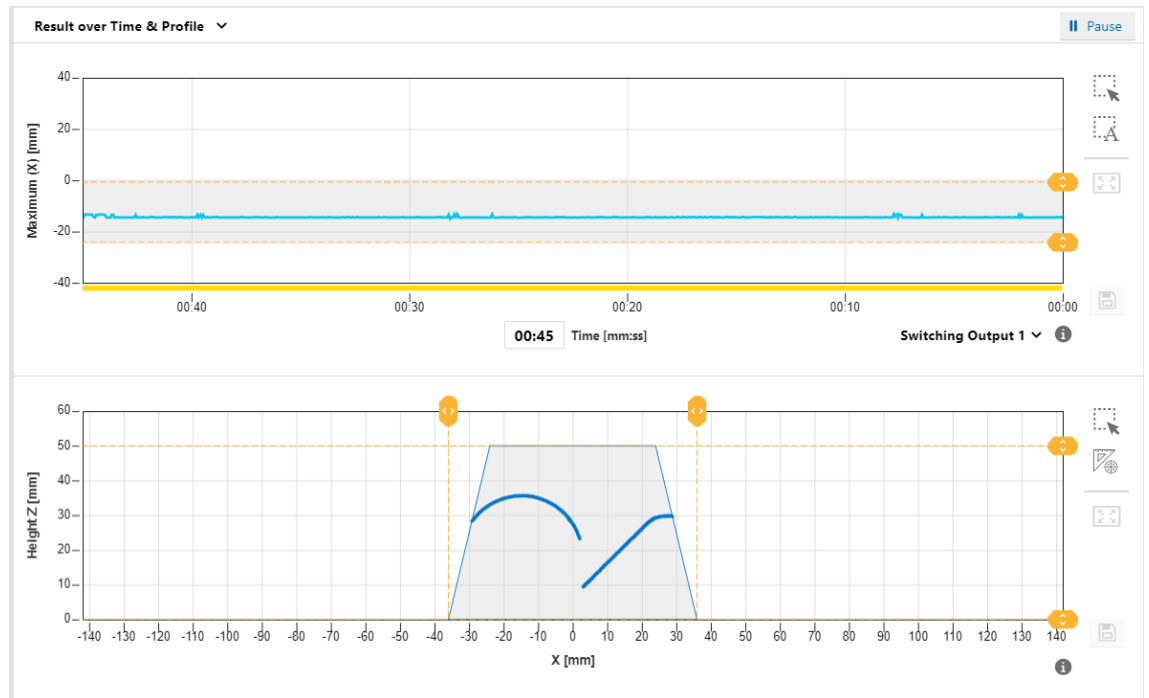

III. 14: Web interface – Parametrization mode – Result over Time & Profile view

The above diagram shows the time curve of the measured value selected in the **Measurement Results** window. The grey background and the dotted orange lines indicate the switching output window or the switching point. This diagram corresponds to the view in the **Monitoring** mode (see [Mode Monitoring \[▶ 37\]](#)).

The bottom diagram shows the profile points of the object. The field of view comes with a grey background. Saving the measured data does not include the profile points (x-z). You can narrow down the measurement field by drag & drop and the yellow lines. The change is immediately adopted. As soon as the measurement field has been narrowed down, any area outside the measurement field is no longer available for further processing.

Optionally, the displayed profile can be saved as a CSV file via the web interface. The CSV file stores the profile points (x-z) in mm units and a timestamp from the host. For doing so proceed as follows:

- In the visualisation area click the button **Pause**.
 - ✓ The currently displayed measured data are frozen.
- Click the diskette symbol in the visualisation area to the right of the profile graph.
- The file is saved in the .csv format.

Profile & Camera Picture

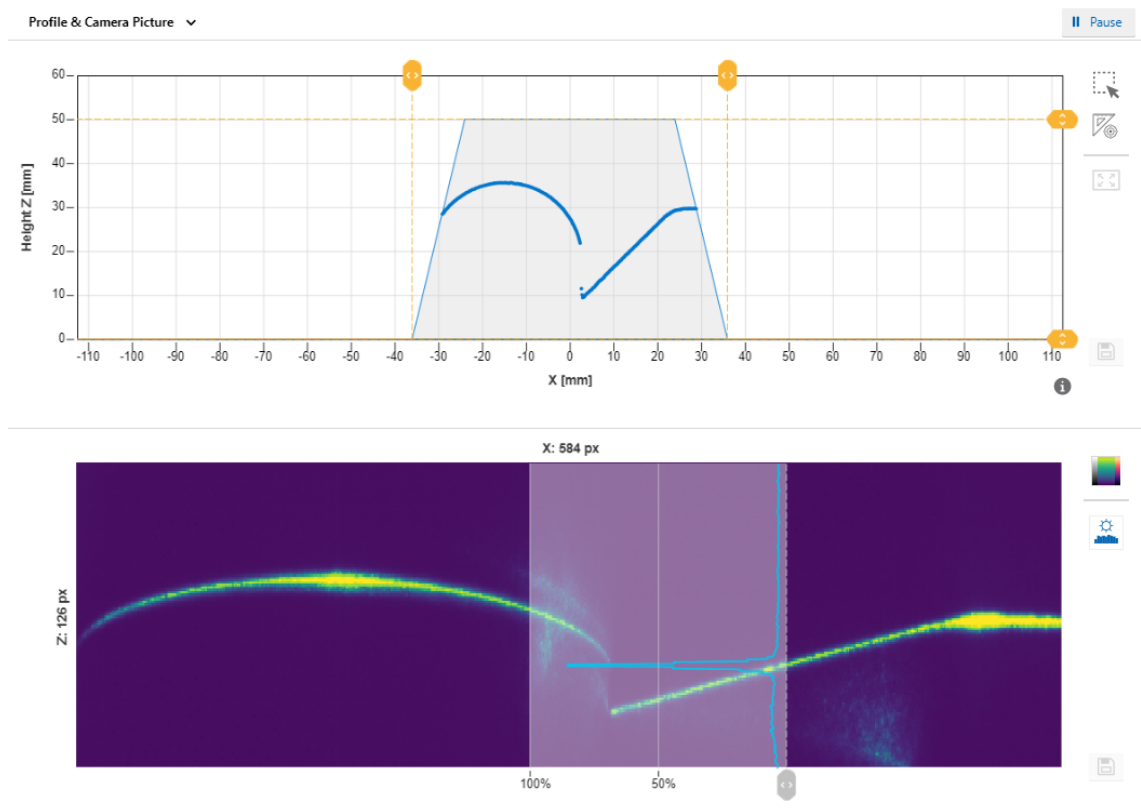

III. 15: Web interface – Parametrisation mode – Profile & Camera Picture view

The top diagram shows the profile points of the object. This diagram corresponds to the bottom diagram in the **Result over Time & Profile** view.

The bottom diagram shows the camera image. This allows the detection of unwanted reflections, for example. The image can be presented in false colours via the top button to the right of the camera image. This can help you set the correct exposure time or find unwanted reflections. The lower button can be used to show an overlay indicating a cut along a select camera column. The overlay indicates the intensity of the column. The active column can be freely selected by the grey slider underneath the camera image.

Intensity & Camera Picture

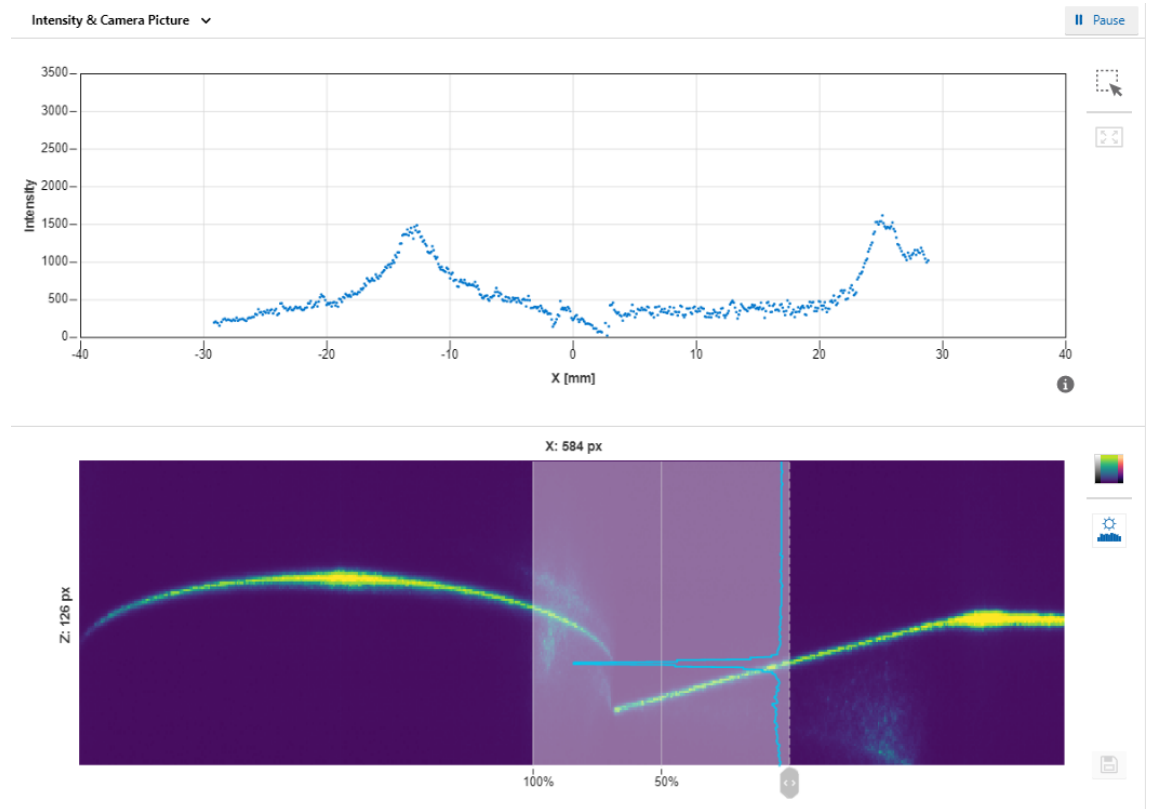

III. 16: Web interface – Parametrisation mode – Intensity & Camera Picture view

The top diagram is a measure of the intensity of the pixels along a column. This view allows you to recognise artefacts in the profile graph and to trace them back to the structure of the surface.

The bottom diagram shows the camera image. This diagram corresponds to the bottom diagram in the **Profile & Camera Picture** view.

The web interface offers the option of saving the displayed profile as a PNG file containing the unprocessed camera image. For this process, proceed as follows:

- a) In the visualisation area click the button **II Pause**.
 - ✓ The currently displayed measured data are frozen.
- b) Click the diskette symbol in the visualisation area to the right of the camera image.
- c) The file is saved in the .png format.

Profile & Intensity

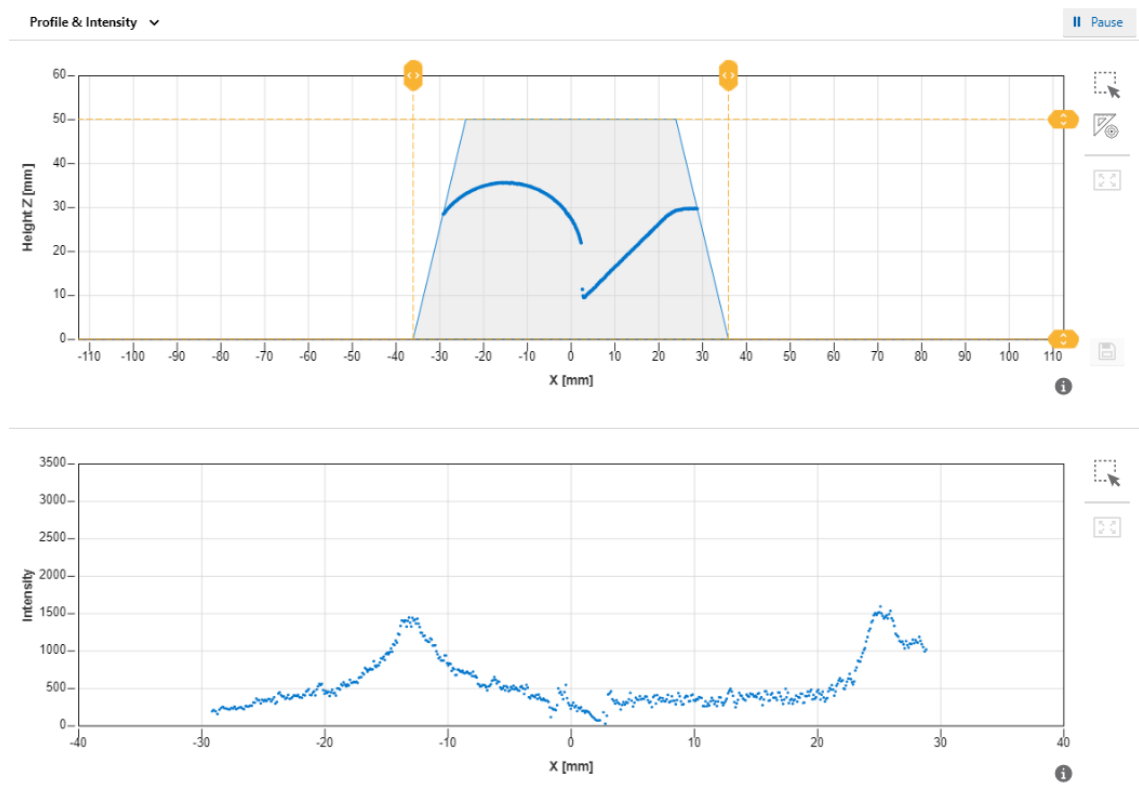

III. 17: Web interface – Parametrisation mode – Profile & Intensity view

The top diagram shows the profile points of the object. This diagram corresponds to the bottom diagram in the **Result over Time & Profile** view.

The bottom diagram shows the summarised pixel values along a column. This diagram corresponds to the top diagram in the **Intensity & Camera Picture** view.

Profile

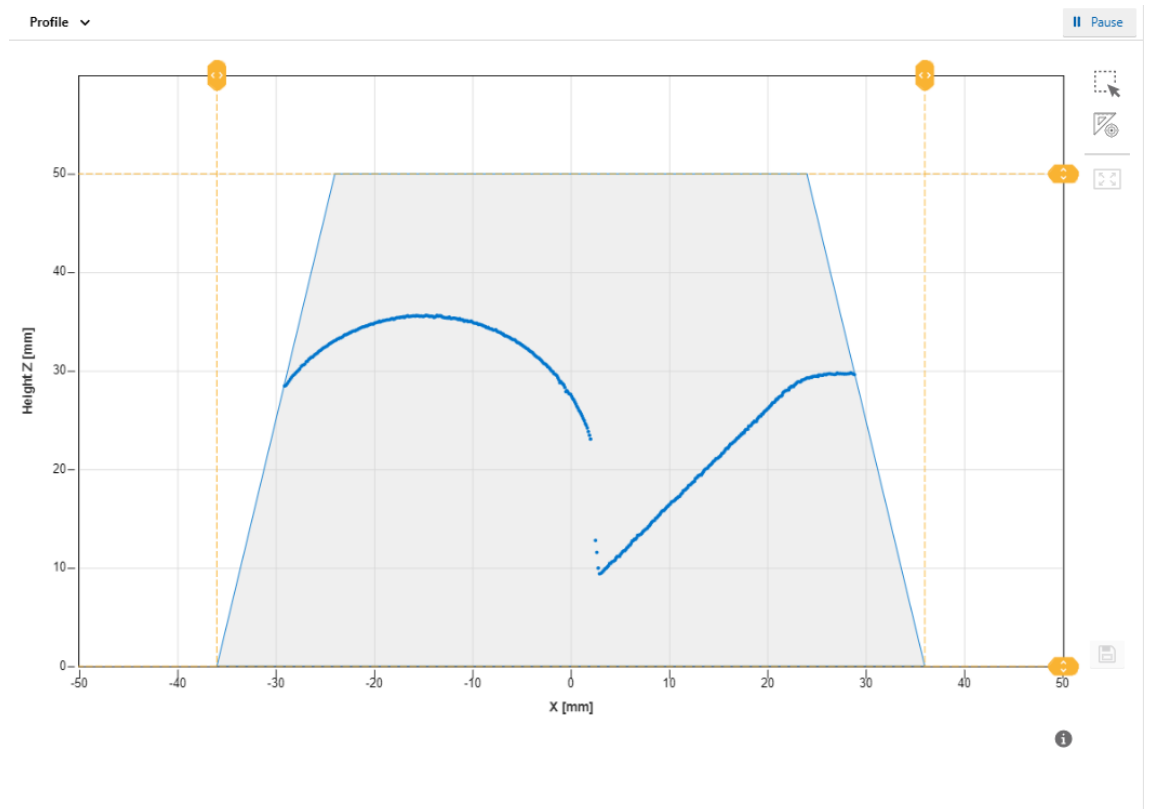

III. 18: Web interface – Parametrisation mode – Profile view

The diagram in this view shows the profile points of the object. This diagram corresponds to the bottom diagram in the **Result over Time & Profile** view.

9.2.2 Adjusting the internal resolution

Adjusting the internal resolution allows you to adjust the number of pixels transferred by the camera. While this affects the measurement rate positively, it lowers the resolution and must therefore be adjusted individually to the application. For this process, proceed as follows:

Condition:

⇒ The **Expert Mode** is activated (see [Header ▶ 34](#)).

Instruction:

- Select mode **Parametrization | Global Parametrization** in the menu.
- In the **Global Parameters** window, proceed to **Data Acquisition | Internal Resolution**.
- In the drop-down list next to **Number of points in x**, select the desired number of points along the X axis that should be read out by the camera of the sensor.
- In the drop-down list next to **Binning in z**, select whether points along the Z axis should be read out by the camera as a summary and as a combined point.

9.2.3 Optimising the exposure time

The colour and surface of the object influence the amount of reflected light. Dark objects require a longer exposure time than bright objects to obtain the same signal strength. The sensor offers the **Optimize** function for a one-time automatic adjustment of the exposure time. With this function, the sensor determines the optimal exposure time based on the light quantity reflected back from the object. The adjustment involves the entire visible camera image. A reduction of the measuring rate can occur with long exposure times.

To initiate the automatic adjustment of the exposure time, proceed as follows:

Instruction:

- a) Select mode **Parametrization | Global Parametrization** in the menu.
- b) In the **Global Parameters** window, proceed to **Data Acquisition | Exposure Time**.
- c) Place the object to be measured in the field of view of the sensor.
- d) Click the **Optimize** button.

Result:

- ✓ The sensor automatically adjusts the exposure time (once).



INFO

In **Expert Mode**, you have the additional option of manually adjusting the exposure time in the entire area.

9.2.4 Adjusting the laser power

With highly reflective, very light or very dark objects, it may be necessary to adjust the laser power. Only change the laser power if you cannot sufficiently adjust the intensity by optimising the exposure time ([Optimising the exposure time](#) ▶ 44). The general rule is:

- Very light objects: low laser power
- Very dark objects: high laser power

To adjust the laser power, proceed as follows:

Condition:

- ⇒ The **Expert Mode** is activated (see [Header](#) ▶ 34).

Instruction:

- a) Select mode **Parametrization | Global Parametrization** in the menu.
- b) In the **Global Parameters** window, proceed to **Data Acquisition | Laser Power Selection**.
- c) In the drop-down list next to **Laser Power Level**, select the desired level of the laser power.

9.2.5 Calculating the surface profile

Setting the parameters of the algorithm

The web interface offers you the option of adjusting the parameters of the algorithm that is used to calculate the profile graph. The parameters define how the algorithm extracts the profile point from the camera image. The camera image contains several pixels with varying intensity. The algorithm calculates a single value (the focal point) from several pixels found in the camera image. The algorithm uses several parameters to assess which pixels to use and which pixels to ignore.

To set the parameters of the algorithm, proceed as follows:

Condition:

⇒ The **Expert Mode** is activated (see [Header \[▶ 34\]](#)).

Instruction:

- a) Select mode **Parametrization | Global Parametrization** in the menu.
- b) In the **Global Parameters** window, proceed to **Data Acquisition | Profile Computation**.
- c) In the drop-down list next to **Algorithm**, select the desired basic type, which can help accomplish more stable results, especially in case of reflections.

The following basic types are available:

- **Standard:**
In the **Standard** setting with several peaks along a column, the peak with the greatest intensity is always used.
- **Upper CoG:**
In the **Upper CoG** setting with several peaks along a column, the top peak is always used.
- **Lower CoG:**
In the **Lower CoG** setting with several peaks along a column, the bottom peak is always used.

Setting the parameters for accumulating adjacent pixels

Within the above-stated basic types, you can carry out detailed adjustments with the help of the following parameters. These parameters determine whether adjacent pixels are accumulated as a common peak:

- **Min. Peak Height:**
 - Minimum height of a peak to be detected in relative units.
- **Min. Peak Width:**
 - Number of adjacent pixels that must be above the **Pixel Threshold** value.
- **Pixel Threshold:**
Threshold below which the pixels are ignored. The value is given in %. Depending on your choice, this is either a percentage of the maximum possible signal (255) or, as a function of the contrast of the peaks, relative to the background.

Smoothing the profile/filters

With profile smoothing, profile points are averaged with the respective adjacent profile points. This can reduce spatial noise, which can be caused, for example, by the structure of the surface or by speckle patterns. You can set the profile smoothing within the **Profile Computation** area via **Filter**.

9.2.6 Trigger Mode setting

By setting the **Trigger Mode**, you can determine the intervals at which the sensor records the measured values.

To set the trigger mode, proceed as follows:

Instruction:

- a) Select mode **Parametrization** | **Global Parametrization** in the menu.
- b) In the **Global Parameters** window, proceed to **Data Acquisition** | **Trigger Mode**.
- c) Set the desired trigger mode.

The following trigger modes are available:

■ **Free Running:**

The sensor measures constantly at the highest possible frequency (which varies according to the application).

- If the sensor input *IN 1 (sync in)* is connected, the free-running mode runs when the input is set to low level.
- If the sensor input *IN 1 (sync in)* is **not** connected, the free-running mode runs continuously.

■ **Interval:**

Measuring cycle with a fixed internal interval (μs). Use the **Interval** mode for measurement with a precisely defined time interval. The achievable measurement frequencies are theoretically identical to the **Free Running** trigger mode. The sensor attempts to constantly comply with the set interval. However, if the sensor is handling an earlier measurement, the measurement cannot start at the set interval. The sensor then waits until the next defined interval point is reached. This means that the measurements are always taken at a multiple of the set interval.

- If the sensor input *IN 1 (sync in)* is connected, the interval mode runs when the input is set to low level.
- If the sensor input *IN 1 (sync in)* is **not** connected, then the interval mode runs continuously.

■ **Single Shot:**

The sensor records exactly one measured value as soon as it is triggered by an external pulse. The *IN 1 (sync in)* input detects only falling edges (transitions from high level to low level). As soon as the *IN 1 (sync in)* input is set to high, all output functions are frozen in their last state until the next measurement. For the specification of input *IN 1 (sync in)*, please see the data sheet that is available for download at www.baumer.com/OX100.



INFO

Mode **Single Shot** requires the sensor being connected to an external trigger signal during the measuring operation.

9.2.7 Aligning the sensor (height and distance mode)

With the **Sensor Orientation** function, you can set the mode of the sensor (height or distance mode). When changing the mode, you alter the coordination system of the sensor.

To align the sensor, proceed as follows:

Condition:

⇒ The **Expert Mode** is activated (see [Header ▶ 34](#)).

Instruction:

- a) Select mode **Parametrization | Global Parametrization** in the menu.
- b) In the **Global Parameters** window, proceed to **Field of View | Sensor Orientation**.
- c) Set the desired alignment.

You have a choice of the following modes:

- **Height:**
In height mode (object space), the zero point of the Z axis is located in the reference surface away from the sensor (RP_H). The positive direction of the Z axis is pointing to the sensor.
- **Distance:**
In distance mode (sensor space), the zero point of the Z-axis is at the front of the sensor (RP_D). The positive direction of the Z-axis is pointing away from the sensor.

9.2.8 Mounting Assistant



INFO

Baumer recommends mounting the sensor at a right angle towards the reference surface of the object to be measured. The **Mounting Assistant** function of the web interface will support you in doing so. If 90° mounting is not possible, the **Flex Mount** function will compensate mounting angles up to $\pm 30^\circ$.

The **Mounting Assistant** function provides you with the tilt angle and the distance to the reference surface R detected in the field of view (see the following figure).

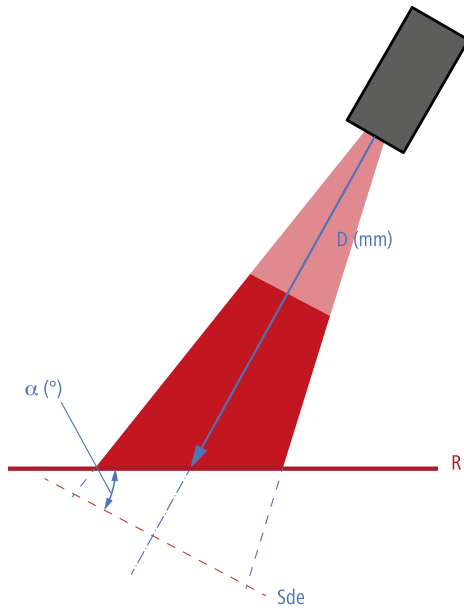

III. 19: Inclination angle and distance to the reference surface

To position the sensor, proceed as follows:

Instruction:

- a) Select mode **Parametrization** | **Global Parametrization** in the menu.
- b) In the **Global Parameters** window, proceed to **Field of View** | **Mounting Assistant**.
- c) Position the sensor.

9.2.9 Flex Mount: Compensating mounting angles



INFO

Function **Flex Mount** is exclusively available in height mode.

With the **Flex Mount** function, you can compensate mounting angles up to $\pm 30^\circ$. This is required if 90° mounting between the sensor and the reference surface is not possible or the background of the measurement object is to be masked. The tilt angle and distance to the reference surface are automatically measured and stored in the sensor. This enables correct rotation of the coordinate system by the software. The profile of the measurement object is determined in line with normal alignment of the sensor to the reference surface (90°).

With angled mounting, the reference point (RP) of the K axis shifts from the centre of the measurement field or the red visible laser line. By angling the sensor, the two sections of the measurement field (measurement field width left (area A) and measurement field width right (area B)) are no longer the same size.

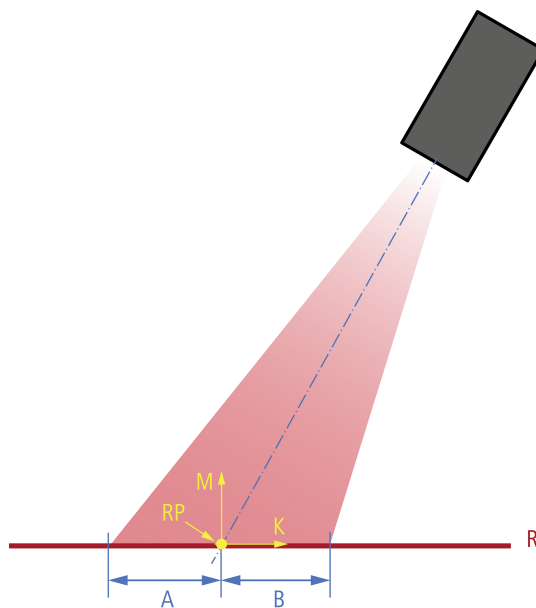

III. 20: Reference point for angled installation

For the teach-in process, make sure that the reference surface is even and that the maximum possible measurement range of the sensor is covered. The detected line must have a minimum length (50 % relative to the field of view width) and must not exceed a maximum roughness. Manual input and compensation are always possible. This function is recommended if the sensor is not aligned normally to the reference surface, e.g., oriented to the base area of the measurement object.

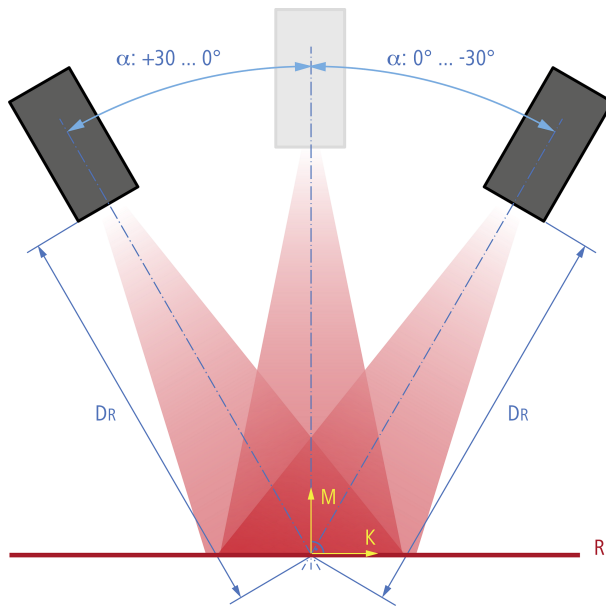

III. 21: Inclination angle and distance to the reference surface with angled installation

To activate the **Flex Mount** function, proceed as follows:

Condition:

- ⇒ The reference surface is within the measurement range (distance between the sensor and the reference surface is less than the measurement range end Sde).
 - ⇒ The maximum tilt angle is $\pm 30^\circ$.
 - ⇒ For uneven reference surfaces: The unevenness must not exceed a maximum value, which depends on the measurement range and the exposure. If required, use an auxiliary plate during teaching in or alternatively adjust the parameters manually.
 - ⇒ There are no undesired objects in the measurement field.
- a) Select mode **Parametrization** | **Global Parametrization** in the menu.
 - b) In the **Global Parameters** window, proceed to **Field of View** | **Flex Mount**.
 - c) Set **Flex Mount** to **On**.
 - d) Click the **Auto** button.
 - e) Confirm with **Teach Flex Mount**.

Result:

- ✓ The coordinate system is rotated.
- ✓ The reference surface is taught in. The original reference point of the sensor is no longer valid.
- ✓ Measurement objects below the reference surface are ignored.
- ✓ The axes are no longer referred to as X and Z axes, but as K and M axes. The denomination does not change on the web interface.
- ✓ The measurement field is reset to the maximum measurement field.

Using an auxiliary plate

To compensate any irregularities in the reference surface you may use an auxiliary plate for the teach-in process. The auxiliary plate should be as even as possible and provide the minimum length of the reference surface $L_{R, \min}$. According to the sensor's sensing range, $L_{R, \min}$ is at approx. 50 % of the field of view depth at the reference distance. Conditions are the same as for teaching of **Flex Mount**. Make sure that the auxiliary plate is parallel to the reference surface underneath. As long as being within the sensor's measurement field, the thickness of the auxiliary plate can be selected at will. In the next step, the thickness may be deducted via the web interface.

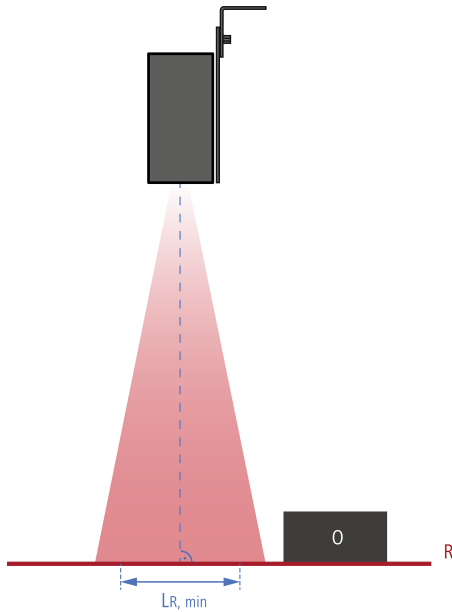

III. 22: Minimum length of the the reference surface $L_{R, \min}$

9.2.10 Flex Mount: Moving the reference surface

Moving the reference surface after teaching in is necessary if you want to deduct the thickness of the auxiliary plate used during teaching in, for example.

Example: When using the **Delta Height** function within **Parametrization | Measurement Tools**, the taught-in reference surface impairs the measurement result.

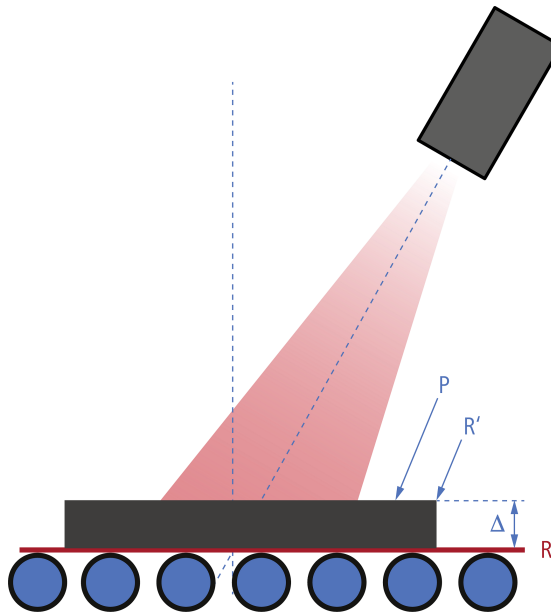

III. 23: Flex Mount: Moving the reference surface

To move the reference surface, proceed as follows:

Instruction:

- Select mode **Parametrization | Global Parametrization** in the menu.
- In the **Global Parameters** window, proceed to **Field of View | Flex Mount**.
- Set **Flex Mount** to **On**.
- Click the **Auto** button.
- In the **Reference** field, enter the value by which the reference surface should be moved (e.g. -5).

Result:

- ✓ The reference surface is placed over the originally taught-in reference surface (of the auxiliary plate), so that it is masked and no longer affects the measurement result.



INFO

If the reference surface should not be moved, the value in the **Reference** field must be 0 mm. As soon as the **Flex Mount** function is activated, the current measurement field is reset to the maximum measurement field.

9.2.11 Resetting Flex Mount

Resetting the **Flex Mount** sets the **angle** to 0° and the **distance** to the *measurement range end Sde*. As soon as the function is reset, the measurement field is equal to the maximum field of view.

To reset **Flex Mount**, proceed as follows:

Instruction:

- a) Select mode **Parametrization | Global Parametrization** in the menu.
- b) In the **Global Parameters** window, proceed to **Field of View | Flex Mount**.
- c) Click the **Reset** button.

9.2.12 Setting the limits of the field of view

You can use the **Field of View Limits** function to set that only part of the camera is read out, thus reducing the field of view (FoV). The profile points outside the set field of view limit are ignored. The function does not affect the width of the laser line.

With the **Set FOV to Max** selection, you reset all limits of the field of view back to the standard settings (maximum measurement field).



INFO

As soon as you use the **Flex Mount** function to teach in a new reference surface, the field of view is maximised.

The **Field of View Limits** function is only recommended if you want to optimise the measurement rate of the sensor. The **Region of Interest Limits** function in the **Measurement Tools Parametrization** mode is available for masking disruptive reflexes or undesired objects. You can set individual evaluation range limits for each stored measurement tool.

9.3 Mode Measurement Tools Parametrization

In **Measurement Tools Parametrization** mode you can allocate measurement tools to the sensor and set the properties of the individual measurement tools. A measurement tool is a function that is predefined in the sensor and which can be used to generate measured values such as height, width or angle, based on the profile data.

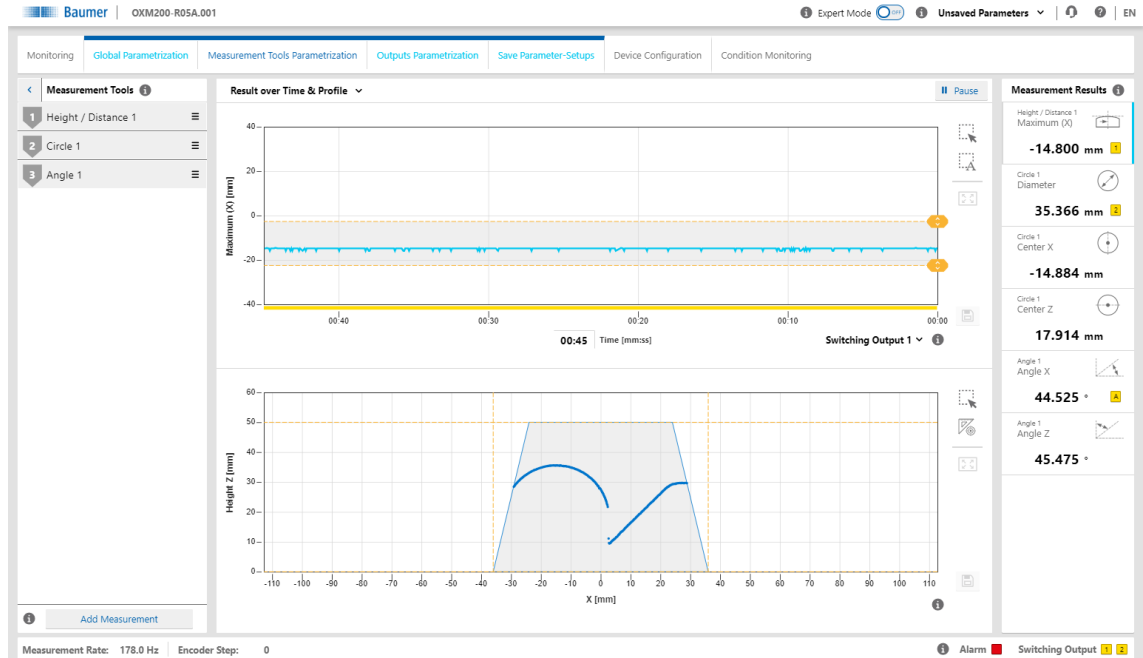

III. 24: Web interface – Measurement Tools Parametrization mode

The order of the measurement tools in the **Measurement Tools** window corresponds to the order of the selected measured value in the measured value array. Click the 3 dashes of the respective measurement tool to change its position or name or to delete the measurement tool. The measuring tool order in the web interface defines the order of the measured values in the protocol.

Measurement tool vs. auxiliary tool

Measurement tools use the profile as input. Auxiliary tools use the output of a measurement tool as input. For an auxiliary tool, the input must be defined before a measured value can be displayed. If the input has not been defined or if a measured value at the input is invalid, NaN (Not a Number) is output. Due to the fact that the measuring tools and the auxiliary tools can also display negative numbers, a number is not possible as error code.

ROI (Region of Interest)

ROI (Region of Interest) is the region where the profile points are included in the evaluation (shown in green on the web interface). You can freely select the ROI (on the web interface with the help of the sliders or the input fields).

Blind region

Blind regions (shown in grey on the web interface) are the regions outside the ROI. Profile points and measured values inside the blind region are ignored in the evaluation. You can freely select the blind regions (on the web interface with the help of the sliders or the input fields).

9.3.1 Setting the position tracking (ROI tracking)

With position tracking (ROI tracking), a measurement can be carried out in a specific region of an object relative to another distinctive feature (e.g. an edge). This way, variations of the object position along the laser line can be compensated.

You can select any measurement point resulting from a previously defined measurement tool as coupling source. For example, the calculation of a mean value can be coupled to the position of an edge. If the position of the edge changes, the position of the ROI is dynamically tracked.

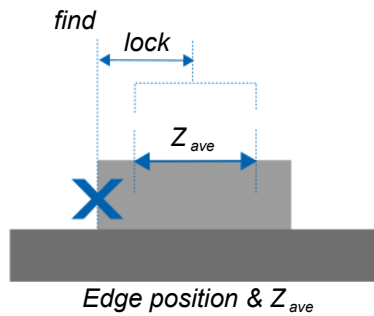

Ill. 25: Position tracking (ROI tracking)

To set the position tracking, proceed as follows:

Instruction:

- a) Select mode **Parametrization | Measurement Tools Parametrization** in the menu.
- b) Create a measuring tool for a characteristic that you want to use as a reference characteristic.
- c) Create a measuring tool for whose position you want to track the measurement.
- d) In the **Measurement Tools** window, go to the desired measurement tool and select **Couple ROI to**.
- e) Open the **Select Tracking Source** drop-down list and select the desired coupling source (as defined in step b).

9.3.2 Setting the background tracking



INFO

Background tracking requires the measuring tool straight/angle. Please refer to the sensor data sheet whether this tool is supported.

With background tracking, you perform a measurement relative to a defined background line. This compensates for fluctuations of the background angle or background height.

You can select a line defined previously in a line / angle measuring tool as the background source. If the position of the background line changes, the position of the ROI is tracked dynamically.

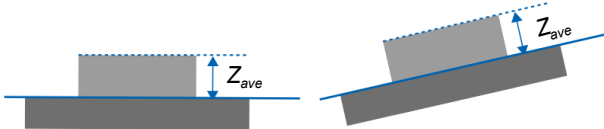

III. 26: Background tracking

To set background tracking, proceed as follows:

Instruction:

- a) Select mode **Parametrization | Measurement Tools Parametrization** in the menu.
- b) Create a line / angle measuring tool and select the range that best resembles the background. If necessary, regions can be excluded by using the blind range function.
- c) Create a measuring tool for which you wish to track the background.
- d) In the **Measurement Tools** window, go to the desired measurement tool and select **Couple Background to**.
- e) Open the **Select Tracking Source** drop-down list and select the desired coupling source (as defined in step b).

9.3.3 Temporal Filter setting

With the **Temporal Filter** function, the noise can be reduced and thus the resolution and repeatability increased. The response and drop-off times are increased and moving objects detected less precisely as a result. The precision filter calculates the results in the form of floating values. The oldest measured value is removed as soon as a new measurement is added. Therefore the measuring frequency is not affected by the precision filter.

To set the **Temporal Filter** function, proceed as follows:

Instruction:

- a) Select mode **Parametrization | Measurement Tools Parametrization** in the menu.
- b) In the **Measurement Tools** window, go to the desired measurement tool and select **Temporal Filter**.
- c) Set the **Temporal Filter** function.

You can set the following filters:

- **Average:**
This filter calculates the average value of an array. You can set the length of the filter.
- **Median:**
This filter calculates the median via a configurable number of measured values that are in a time sequence (sample). The median is defined as the value below which 50 % of the measured values in the sample are located. The median filter can be used to suppress individual outliers. With greater filter lengths, the filter can also suppress several successive outliers.

Example: Calculating the response time with a measurement frequency of 500 Hz

- **Formula:**
 - Response time = $1 / \text{measurement frequency} \times (\text{median} + \text{average})$
- **Sample values:**
 - Measurement frequency: 500 Hz
 - Median = 4
 - Average = 16
- **Calculation:**
 - Response time = $1/500 \text{ Hz} \times (4 + 16) = 0.04 \text{ s} = 40 \text{ ms}$

9.3.4 Processing an invalid measured value

The **Invalid Value Handling** function allows for defining the output holding time of a measured value in the event it is followed by invalid measured values. This way, sudden but expected signal interruptions are compensated. Each measuring tool can be set independently.

To configure the processing of invalid measured values, proceed as follows:

Instruction:

- a) Select mode **Parametrization | Measurement Tools Parametrization** in the menu.
- b) In the **Measurement Tools** window, go to the desired measurement tool and select **Invalid Value Handling**.
- c) Enter the desired holding time for the invalid measured value.

9.4 Mode Outputs Parametrization

In **Outputs Parametrization** mode, you can allocate the corresponding measurement tools to the sensor outputs.

Digital Output 1 / 2

- **Switching Output**
 - Each active measured value or the alarm can be assigned to one of the switching outputs.
 - Select whether the switching output is in point mode (switching point P1) or in window mode (switching point P1 and switching point P2).
 - The behaviour in case of invalid measured values is set separately for the measured value.
 - See also [Processing an invalid measured value \[57\]](#).
 - The alarm output is output as a push-pull signal (Active High) if it has been assigned to one of the switching outputs.
 - The alarm output is active when
 - the profile quality is poor,
 - the sensor is in the parametrisation mode.
- **Hysteresis**
 - Hysteresis input.
 - See also [Setting the hysteresis \[60\]](#).
- **Polarity**
 - Selection of **Active High / Active Low**.
 - With **Polarity**, you can determine how the switching outputs behave depending on the output level. On the web interface the region where the switching outputs are set to high is shown in grey.

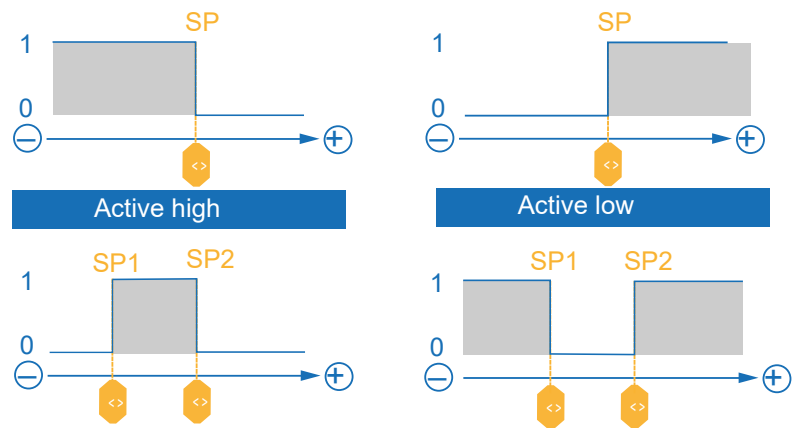

Analog Output

- Each active measured value can be applied to the analogue output.
- You can define the behaviour of the Analog Output for cases where the measured value applied to the Analog Output is not valid (NaN). The following cases are possible:
 - The Analog Output jumps to the minimum or maximum value of the available analogue region,
 - or
 - the last valid measured value is permanently applied to the Analog Output.
- Different types (voltage and current) and regions can be selected for the Analog Output. The minimum/maximum output points refer to the measured values of the analogue output that are scaled to the minimum/maximum region of the analogue output. If required, the gradient of the analogue output can also be inverted.

Profile Output

- For physical reasons, the profile points are not equidistant (due to the exit angle of the laser beam from the sensor and the mounted trapezoid). In the centre of the laser line, the profile points lie closer together than at the edge. Similarly, the profile points lie closer together in the direction of the sensor.
 - Processing of the point cloud is easier for most algorithms if the profile points are uniformly distributed along the X axis.
 - Here, you can select how the profile points are output:
 - **Raw** (not equidistant)
 - **Interpolated** (equidistant)
-

9.4.1 Setting the hysteresis

The hysteresis is the difference between the switching-on and switching-off threshold in mm. Without hysteresis (H), objects near the switching point can lead to a repeated switching of the switching output. It is recommended to use a hysteresis with a value at least as high as the resolution of the sensor. You can enter the hysteresis as a positive or negative value. The minimum value of the hysteresis depends on whether the hysteresis is positive or negative. In both cases, the minimum value is selected so that the distance between the switching points equals zero.

Negative hysteresis

The hysteresis is situated between the switching points (window mode) or points towards lower measured values (point mode). With a negative hysteresis, the minimum distance of the switching points is equal to the value of the hysteresis times two.

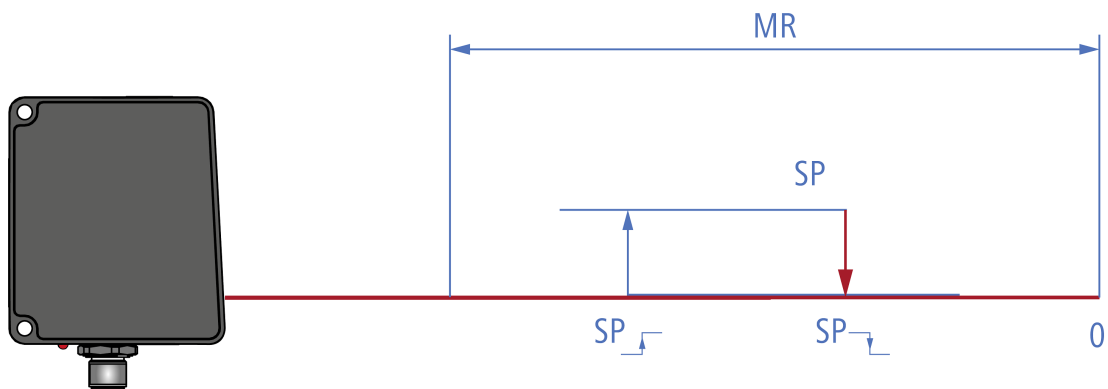

III. 27: Negative hysteresis

Positive hysteresis

The hysteresis is situated outside the switching points (window mode) or points towards larger measured values (point mode). With a positive hysteresis, the minimum distance of the switching points is 0.

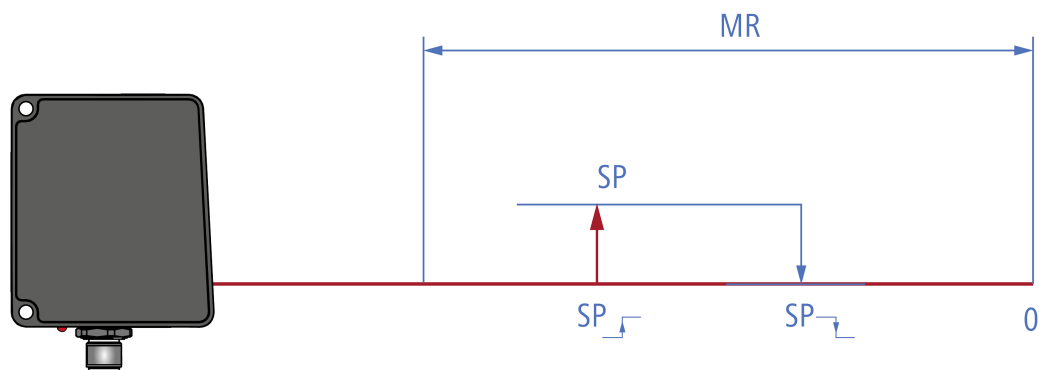

III. 28: Positive hysteresis

Behaviour of the switching output in point mode

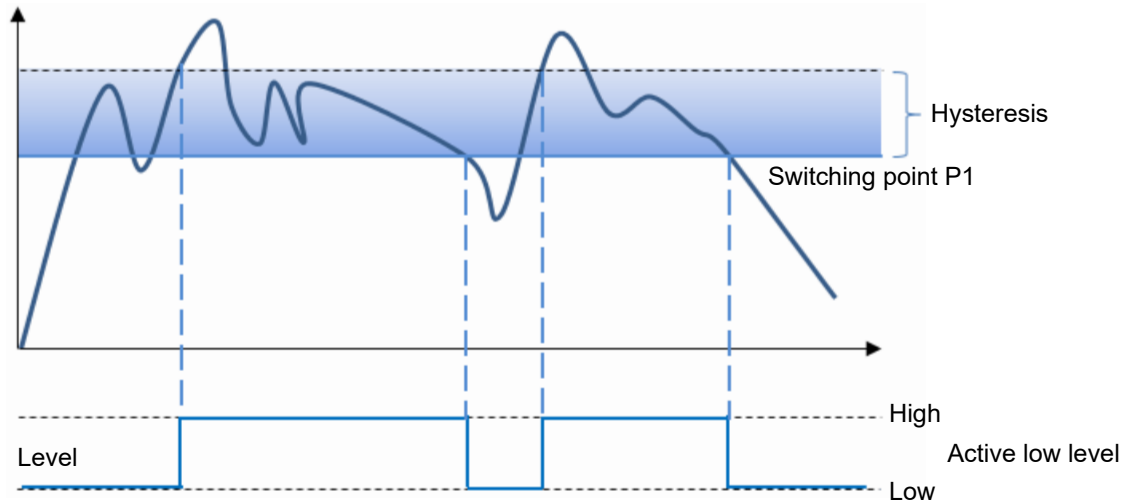

III. 29: Behaviour of the switching output in point mode (positive hysteresis)

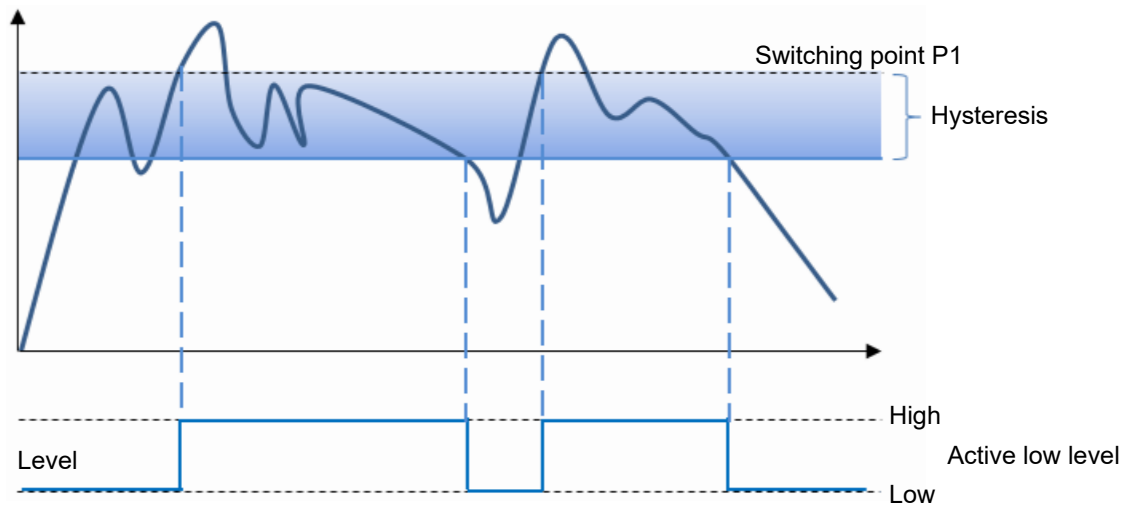

III. 30: Behaviour of the switching output in point mode (negative hysteresis)

Behaviour of the switching output in window mode

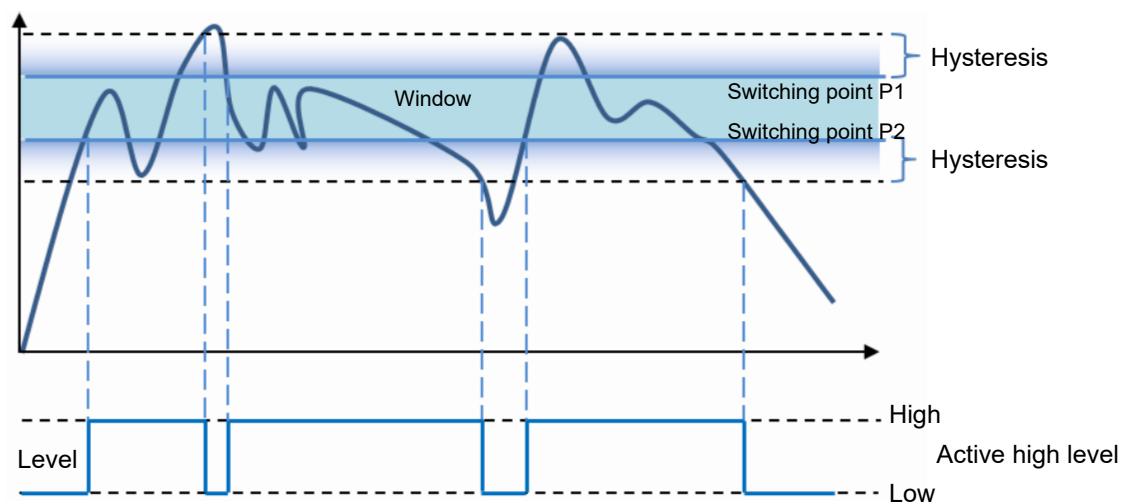

III. 31: Behaviour of the switching output in window mode (positive hysteresis)

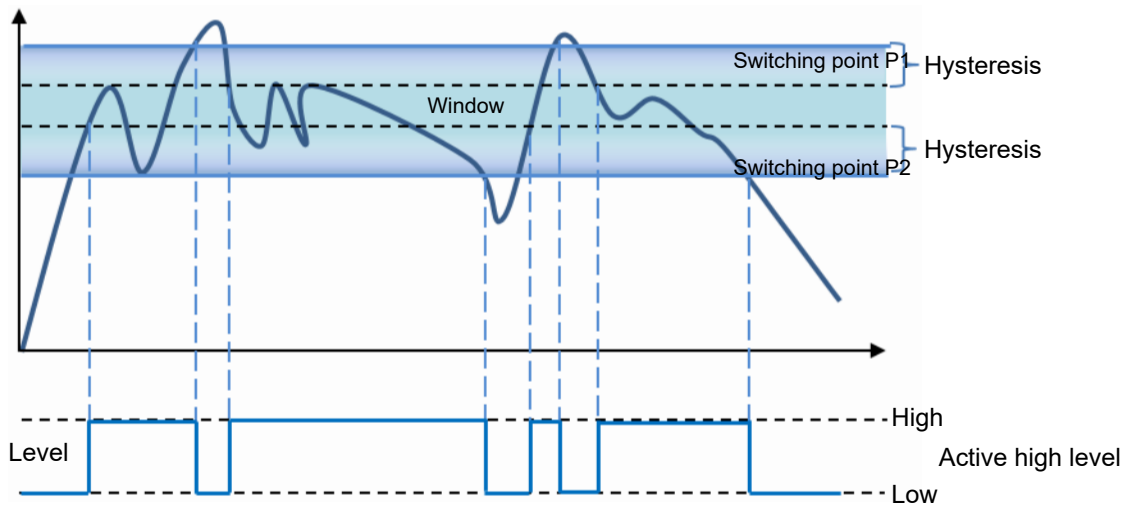

III. 32: Behaviour of the switching output in window mode (negative hysteresis)

Polarity

With **Polarity**, you can invert the level with **Active High** or **Active Low**.

9.5 Mode Save Parameter-Setups

You can save up to 32 parameter setups in the **Save Parameter-Setups** mode. In addition, you have the option to export and re-import parameter setups. External storage is in the .json format. The JSON file can be transferred to sensors with identical type code (measurement range and interface). The parameter setups can be renamed individually using the Web interface. Individual parameter setups can be saved, load or deleted. They are referenced via the process interfaces through use of a unique number, which can also be displayed in the Web interface.

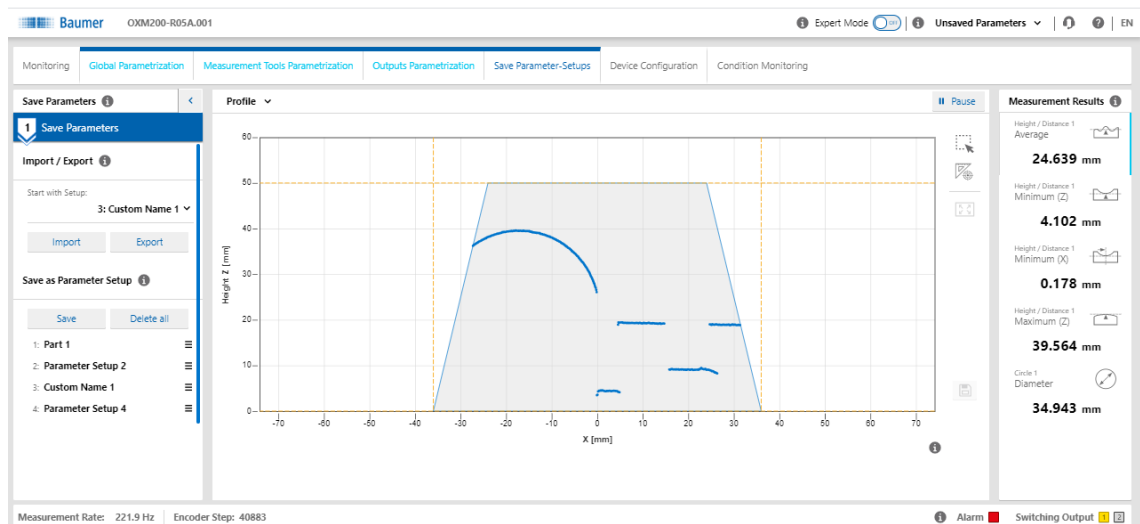

III. 33: Web interface – Save parameter setup mode

9.6 Mode Device Configuration

In **Device Configuration** mode, you can carry out device-specific settings.

III. 34: Web interface – Device Configuration mode

Sensor Info

- Display of the sensor characteristics.
Please pass on this information should you require customer service.
- The MAC address and production date are found on the name plate of the sensor (silver label on the sensor).

– **Sensor Type**

- Display of the sensor type.

– **Serial Number**

- Display of the serial number of the sensor.

Network

- Selection between static and dynamic address configuration.

– **Static IP Address**

- The sensor uses a fixed IP address.

– **IP Address**

- Input IP Address.

– **Subnet Mask**

- Input Subnet Mask.

– **Standard Gateway**

- Input Standard Gateway.

– **DHCP**

- Activate/ deactivate DHCP.
DHCP will activate automated address allocation according to AutoIP.

Time Synchronization

- The time stamps of the measured values are set according to the synchronisation. UTC is the time basis.
Note: The daylight savings time function is not supported!

– **NTP**

- Activation/deactivation of the NTP synchronisation:
When NTP is activated, the sensor synchronises its internal clock with a defined time server of the network.

– **Time Server**

- Input Time Server of the network.

Process Interface	<ul style="list-style-type: none"> ■ Activation/deactivation of the process interfaces. ■ If deactivated, the sensor no longer responds to queries via this protocol. ■ The protocols can be used in parallel.
– Modbus RTU	<ul style="list-style-type: none"> ■ Activate/ deactivate Modbus RTU. ■ Setting the communication parameters (slave address, data bits, number of stop bits, parity, baud rate). ■ See also Modbus RTU [▶ 18], Set up RS485 interface with Modbus RTU [▶ 31].
– IO-Link process data type	<ul style="list-style-type: none"> ■ Switching the process data width between 16 und 32 bits. ■ Restart sensor to activate. ■ Sensor logs on with the respective IODD Device ID.
Web Interface & Firmware	<ul style="list-style-type: none"> ■ Display of the web interface software and firmware version. ■ Uploading updated web interface software (.img format) and firmware (.fup format). <ul style="list-style-type: none"> ▪ It is possible to install a more recent revision of the firmware on the sensor, as long as the compatibility of the firmware is not excluded by the release notes. ▪ Downgrading the firmware is also possible. However, only down to the firmware with which the sensor was delivered.
– Security	<ul style="list-style-type: none"> ■ Activation/deactivation of Password Protection.
– Factory Reset	<ul style="list-style-type: none"> ■ Resetting the sensor to factory settings.
– Settings Reset	<ul style="list-style-type: none"> ■ Resetting the sensor settings. The IP address is not reset in this process.

10 Preventive maintenance

The sensor is maintenance-free. No special preventive maintenance is required. Regular cleaning and regular checking of the plug connections are recommended.

10.1 Cleaning the sensor

External cleaning

When cleaning the exterior of the sensor, make sure to use cleaning agents that do not affect the housing surface and seals.

NOTICE

Material damage due to improper cleaning.

Unsuitable cleaning agents and methods can cause leaks and damage the sensor, the seals or the connections.

- a) Always check the suitability of the cleaning agent for the surface to be cleaned.
 - b) Use alcohol-based cleaning agents but never any scouring agents, solvents or other aggressive cleaning agents.
 - c) Never use a high-pressure cleaner for cleaning.
 - d) Do not scrape off soiling with sharp-edged items.
 - e) Only use lens cleaning cloths for the front pane of the sensor.
-

Interior cleaning

No interior cleaning of the sensor is required.

11 Troubleshooting

CAUTION

Release of dangerous laser radiation when the sensor is defective.

Use of the sensor with a fractured front panel or loose/exposed laser optics can release dangerous laser radiation.

- a) In case of a fractured front panel or loose/exposed laser optics disconnect the laser from the power immediately.
- b) Have the sensor checked by an authorised person (specialist). Do not operate the sensor until that time.

11.1 Resetting the sensor to the factory settings

Resetting the sensor to the factory settings is necessary, for instance, if the IP address of the sensor was changed and you can no longer connect to the sensor. Proceed as follows:

Instruction:

- a) Disconnect the sensor from the power supply.
- b) Connect OUT 1 to OUT 2 (see [Pin assignment \[▶ 28\]](#)).
- c) Connect the sensor to the power supply.
- d) Connect to sensor as described in [Connecting the sensor to the PC \[▶ 29\]](#). Apply the default settings.
 - ✓ A special page opens.
- e) Select **Factory Default** and wait for the response from the sensor.
- f) Separate OUT 1 and OUT 2.
- g) Select **Restart sensor**.

Result:

- ✓ The sensor is now reset to the factory settings.

11.2 Return and repair

In case of complaints, please contact the relevant sales company.

11.3 Accessories

You can find accessories at the website at:

<https://www.baumer.com>

12 Technical data

The technical data for your sensor can be found in the data sheet available for download at www.baumer.com/OX200.

12.1 Dimensional drawing

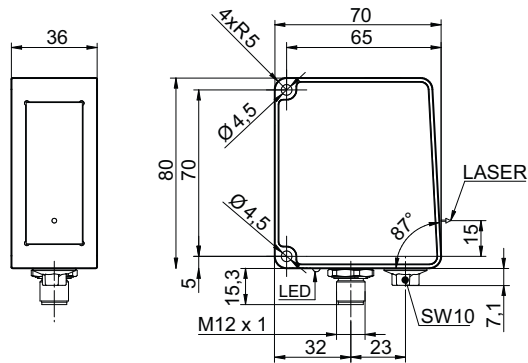

III. 35: Dimensional drawing

List of illustrations

III. 1	Name plate on the sensor.....	6
III. 2	Structure	9
III. 3	Triangulation principle.....	10
III. 4	Functionality.....	10
III. 5	Measurement rate limited by exposure time	11
III. 6	Measurement rate limited by calculation time.....	12
III. 7	Reference surfaces.....	12
III. 8	Measurement field	13
III. 9	Transmission and receiving axis.....	14
III. 10	Web interface – Overview.....	15
III. 11	Web interface – user interface	33
III. 12	Web interface – Monitoring mode.....	37
III. 13	Web interface – Global Parametrization mode	38
III. 14	Web interface – Parametrisation mode – Result over Time & Profile view	39
III. 15	Web interface – Parametrisation mode – Profile & Camera Picture view.....	40
III. 16	Web interface – Parametrisation mode – Intensity & Camera Picture view	41
III. 17	Web interface – Parametrisation mode – Profile & Intensity view	42
III. 18	Web interface – Parametrisation mode – Profile view	43
III. 19	Inclination angle and distance to the reference surface	48
III. 20	Reference point for angled installation	49
III. 21	Inclination angle and distance to the reference surface with angled installation	50
III. 22	Minimum length of the the reference surface $L_{R, min}$	51
III. 23	Flex Mount: Moving the reference surface	52
III. 24	Web interface – Measurement Tools Parametrization mode.....	54
III. 25	Position tracking (ROI tracking).....	55
III. 26	Background tracking	56
III. 27	Negative hysteresis	60
III. 28	Positive hysteresis	60
III. 29	Behaviour of the switching output in point mode (positive hysteresis)	61
III. 30	Behaviour of the switching output in point mode (negative hysteresis).....	61
III. 31	Behaviour of the switching output in window mode (positive hysteresis).....	61
III. 32	Behaviour of the switching output in window mode (negative hysteresis).....	62
III. 33	Web interface – Save parameter setup mode	62
III. 34	Web interface – Device Configuration mode	63
III. 35	Dimensional drawing	67

