



Description of functions and interfaces

IF200 with IO-Link and Analog Output
Inductive Sensor

EN-US

Table of contents

1	About this document	5
1.1	Purpose and scope of application	5
1.2	Applicable documents	5
1.3	Labels in this manual	5
1.4	Warnings in this manual	5
2	Overview	6
2.1	General functionality	6
3	Interfaces	7
3.1	IO-Link.....	7
3.2	qTeach	8
4	Functions	9
4.1	Process data	9
4.2	Operating functions	11
4.2.1	System commands	11
4.2.1.1	Factory settings	11
4.2.2	Measured values.....	12
4.2.2.1	Distance/Frequency	12
4.2.2.2	Counter.....	13
4.2.3	MDC configuration	14
4.2.3.1	MDC source.....	14
4.2.3.2	MDC descriptor.....	14
4.2.4	SSCx configuration	15
4.2.4.1	Switching points	15
4.2.4.2	Switching logic.....	18
4.2.4.3	Switching mode	20
4.2.4.4	Hysteresis.....	21
4.2.4.5	Time filter.....	23
4.2.4.6	Counter / SSC4	26
4.2.5	Teaching.....	28
4.2.5.1	Static teaching.....	29
4.2.5.2	Dynamic teaching.....	31
4.2.5.3	Scaling analog output.....	31
4.2.6	Signal processing.....	33
4.2.6.1	Filter / Measuring mode.....	34
4.2.6.2	Scaling of the input characteristic.....	34
4.2.7	Input/Output Settings	37
4.2.7.1	Switching output	37
4.2.7.2	Analog output	37
4.2.8	Device access lock	38
4.2.8.1	Data Storage	38
4.2.9	Local user interface.....	38
4.2.9.1	LED indicator	38
4.2.9.2	qTeach lock	39
4.3	Diagnostic functions	40

4.3.1	Operating hours	40
4.3.2	Device status	40
4.3.3	Device temperature.....	40
4.3.4	Identification.....	41
4.3.5	Supply voltage	41
4.3.6	Histogram.....	42
5	Annex	45
5.1	IO-Link.....	45
5.1.1	PDI.....	45
5.1.2	Identification.....	46
5.1.3	Parameter	46
5.1.3.1	System Commands	46
5.1.3.2	Measurement Values	47
5.1.3.3	MDC Configuration	48
5.1.3.4	SSC1 Configuration.....	48
5.1.3.5	SSC2 Configuration.....	49
5.1.3.6	SSC3 Configuration.....	51
5.1.3.7	SSC4 Configuration.....	52
5.1.3.8	Teach.....	53
5.1.3.9	Signal Processing.....	55
5.1.3.10	Input/Output Settings.....	56
5.1.3.11	Local User Interface	57
5.1.3.12	Device Access Locks.....	57
5.1.4	Diagnosis	58
5.1.4.1	Device Status	58
5.1.4.2	Device Temperature	59
5.1.4.3	Operation Time.....	60
5.1.4.4	Power Supply	60
5.1.4.5	Histogram	61
5.2	<i>qTeach</i> [®]	64
5.2.1	Teach level overview	64

List of illustrations

III. 1	Inductive sensor: Function principle (schematic representation)	6
III. 2	IO-Link architecture	7
III. 3	Measured values	12
III. 4	Sensor in measuring mode <i>Single Point</i>	20
III. 5	Sensor in measuring mode <i>Two Point</i>	20
III. 6	Sensor in measuring mode <i>Window</i>	20
III. 7	Hysteresis	21
III. 8	Switching output behavior in mode <i>Single Point</i> and negative hysteresis (<i>Left Aligned</i>)	21
III. 9	Switching output behavior in mode <i>Window</i> and negative hysteresis (<i>Left Aligned</i>)	22
III. 10	Switching output behavior in mode <i>Single Point</i> and negative hysteresis (<i>Left Aligned</i>)	22
III. 11	Switching output behavior in mode <i>Window</i> and negative hysteresis (<i>Right Aligned</i>)	22
III. 12	<i>Response Delay</i>	24
III. 13	<i>Release Delay</i>	24
III. 14	<i>Minimum Pulse Duration</i>	25
III. 15	SSC4/Counter behavior: Single Point or Window, Autoreset enabled or disabled	27
III. 16	<i>Single Point Teach</i> , switching behavior after successful teaching operation, hysteresis aligned to the right	29
III. 17	<i>Two Point Teach</i> , switching behavior after successful teaching operation	29
III. 18	<i>Window Teach</i> , switching behavior after successful teaching operation, hysteresis aligned to the right	30
III. 19	Reduced value range of analog output to improve accuracy (analog value increasing with distance)	31
III. 20	Reduced and inverted value range of analog output for improved accuracy and different slope (analog value decreasing with distance)	31
III. 21	Signal processing chain (diagram)	33
III. 22	Filter has an influence on resolution	34
III. 23	Scaling - In vs out	35
III. 24	Scaling – <i>Fixed Slope Gradient</i> , Teach Corner 1	35
III. 25	Scaling – <i>Fixed Slope Gradient</i> , Teach Corner 2	36
III. 26	Histogram of the device temperature (lifetime), example	43

1 About this document

1.1 Purpose and scope of application

This document enables safe and efficient sensor parameterization using various interfaces. The manual describes the available functions to support installation and software use via the interfaces.

The illustrations are examples only. Deviations are at the discretion of Baumer at all times. The manual is a supplementary document to the existing product documentation.

1.2 Applicable documents



- Download at www.baumer.com:
 - Data sheet
 - EU conformity declaration
- As a product insert:
 - General information insert (11042373)

1.3 Labels in this manual

Identifier	Use	Example
<i>Dialog element</i>	Indicates dialog elements.	Click the OK button.
<i>Unique name</i>	Indicates the names of products, files, etc.	<i>Internet Explorer</i> is not supported in any version.
Code	Indicates entries.	Enter the following IP address: 192.168.0.250

1.4 Warnings in this manual

Warnings draw attention to potential personal injury or material damage. The warnings in this manual indicate different hazard levels:

Symbol	Warning term	Explanation
	DANGER	Indicates an imminent potential danger with high risk of death or serious personal injury if not being avoided.
	WARNING	Indicates potential danger with medium risk of death or (serious) personal injury if not being avoided.
	CAUTION	Indicates a danger with low risk, which could lead to light or medium injury if not avoided.
	NOTE	Indicates a warning of material damage.
	INFO	Indicates practical information and tips that enable optimal use of the devices.

2 Overview

2.1 General functionality

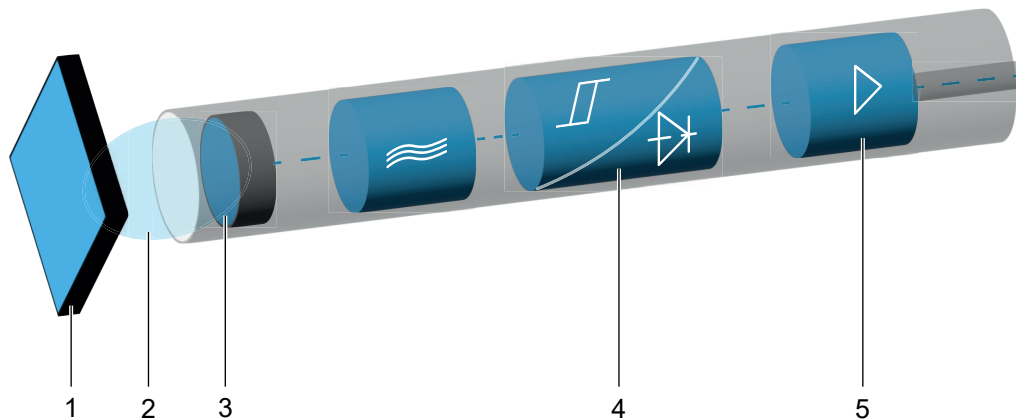

III. 1: Inductive sensor: Function principle (schematic representation)

1	Damping object	2	Measurement field
3	Active surface	4	Trigger stage signal converter
5	Output amplifier		

Using an oscillating circuit, the oscillator generates an electromagnetic alternating field emitting from the active sensor surface. Any metal object approaching the front will induce eddy currents draining energy from the oscillator. The level change at the oscillator output switches the output stage of digital sensors via Schmitt trigger. In measuring sensors, the level change will influence the analog output signal in relation to the object distance.

3 Interfaces

This section describes the available interfaces for operator to sensor communication.

Please note that not any sensor function can be parameterized by any interface. The number of parameterizable functions depends on the selected interface.

3.1 IO-Link

IO-Link enables manufacturer-independent digital, bidirectional point-to-point communication. For this purpose, actuators or sensors are connected to an IO-Link master by standardized 3-wire connecting cables.

The IO-Link interface serves for parameterization of the sensor functions. In addition, measurement data and the function-generated sensor and status information are digitally transmitted in the form of process data to the machine controller (PLC). Secondary data informing on the machine condition allow for continuous process monitoring and process optimization.

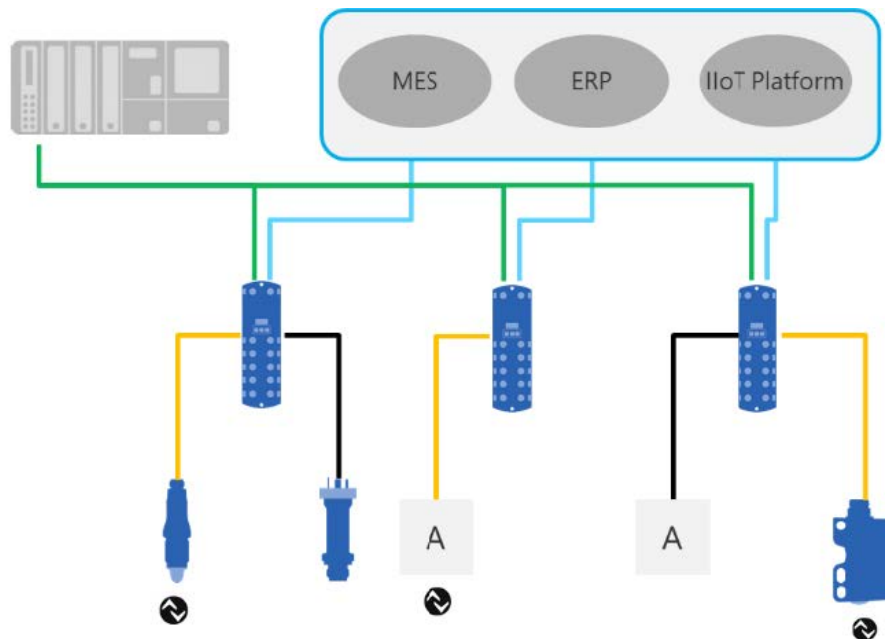

III. 2: IO-Link architecture

The IO-Link master clustering several sensors connects the controller via the respective fieldbus system, which is the so-called operational technology communication (OT communication). In addition, another Ethernet-based connection to the IO-Link master (e.g., via OPC UA or MQTT) enables direct communication between sensor and IT systems (IT communication).

There are two types of communication between IO-Link master and device.

- **Cyclic communication:**
Transmission in real time - This information of this process data is used for process control in automation systems.
- **Acyclic communication:**
Time-uncritical communication for transmission of secondary data or for sensor parameterization.

To address both sensor functions and secondary data correctly, IO-Link interface description utilizes the so-called IODD (IO Device Description). IODD is available for download on the sensor website (download section). Digital sensor communication, secondary data and the option of direct sensor communication with the IT world makes IO-Link a cornerstone in Smart Factory.

**INFO**

For evaluation, parameterization and use of IO-Link sensors, Baumer provides both IO-Link USB-C master and Baumer Sensor Suite. The IO-Link USB-C Master enables IO-Link devices to communicate with the computer without external power supply. Baumer Sensor Suite is a computer-based tool to understand and use IO-Link devices and to visualize sensor functions of different sensor brands. This allows for engineering both at the workplace and straight at the machine. For more information, visit baumer.com/bss.

3.2**qTeach**

Some sensor functions enable parameterization via the Baumer *qTeach* feature. For parameterization using *qTeach*, simply touch the teaching field market at the sensor with a ferromagnetic tool.

During the parameterization operation, the sensor-integrated LED provides you with visual feedback.

Parameterization via *qTeach* is enabled in the factory settings and can be disabled via IO-Link.

**INFO**

Parameterization via teach is accessible for the first 5 minutes after sensor power on. This time having expired, *qTeach* is disabled. If *qTeach* is enabled within these first 5 minutes, *qTeach* will remain enabled for another 5 minutes. Editing the time window is using IO-Link.

4 Functions

4.1 Process data

If the sensor is in IO-Link communication mode, the process data is exchanged cyclically between the IO-Link master and the sensor (sensor<>IO-Link master). The IO-Link master needn't explicitly request the process data.

Process Data In (PDI)

Process Data In is a 32bit string using the structure of the Smart Sensor Profile Definition PDI32.INT16_INT8.

Bit	Function	Description
0	SSC1	Switching Signal Channel 1 & Channel 2
1	SSC2	Digital representation of switching outputs: <ul style="list-style-type: none"> ▪ 0 : No object present within the switching range (Logic: standard) ▪ 1 : Object present within switching range (Logic: standard)
2	–	
3	Alarm	The alarm bit indicates a problem identified in sensor configuration or function. <ul style="list-style-type: none"> ▪ 0 : Sensor continues standard operation. ▪ 1 : A problem in sensor configuration or function has been identified.
4	SSC3	Switching Signal Channel 3 (Frequency) SSC3 configuration allows for binary signal setup in relation to frequency measurement.
5	SSC4	Switching Signal Channel 4 (Counter) SSC4 configuration allows for binary signal setup in relation to the number of SSC1 or SSC2 switching operations. Integrated auto-reset and time filter enable setup of a full-featured batch counter for lot sizes without the need for any PLC software programming.
6	–	
7	–	
8 ... 15	Scale	The value is the exponent in powers of ten applied to the MDC (measurement data channel) value. Example: <ul style="list-style-type: none"> ▪ Value of MDC: 1000 ▪ Unit: m ▪ Scale: 6 ▪ Means: $1000 \cdot 10^{-6}$ m or 1000 μm Inductive IO-Link sensors only deliver measured values without need for scaling factor, reason why the scaling factor is permanently 0 (zero).

Bit	Function	Description
16 ... 31	Measurement Data Channel (MDC)	Channel can be used to read out the distance value or switch numbers of SSC1, 2, 3 or 4 as a 16-bit integer value.

Tab. 1: Process Data In

Process Data Out (PDO)

Cyclic transmission of this data from IO-Link master to sensor.

Bit	Function	Description
0	Disable Oscillator	Changing this bit will disables the oscillator. This is oscillator switch off but no electronics switch off. The sensor will not provide nay measured or switching value. This might be useful in sequential measuring operations with neighboring sensors. The command may shortly interrupt communication.
1	Find Me	Signaling e.g. by flashing sensor LEDs for localization and physical sensor identification in machines or installations.

Tab. 2: Process Data Out

4.2 Operating functions

4.2.1 System commands

4.2.1.1 Factory settings

The *Reset* function will restore the factory settings. Default will be restored in the entire user settings.

For more detailed information on the following please refer to chapter [Annex | 45](#).

IO-Link access: factory settings

Name	Index	Subindex	Description
System Command	2	–	Restore factory settings.

Teach access (Level 4): Factory settings



INFO

qTeach will only reset the parameters set using *qTeach*.



INFO

All LEDs light up for 1s when touching the teach field at the sensor with a ferromagnetic tool (tool has been recognized).

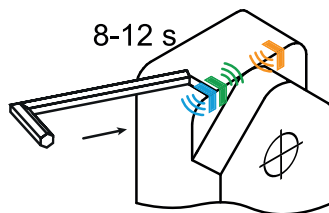

Touch the teach field marked at sensor with a ferromagnetic tool and hold for 8 s.

- The blue, green and yellow LEDs are flashing slowly (1 Hz).

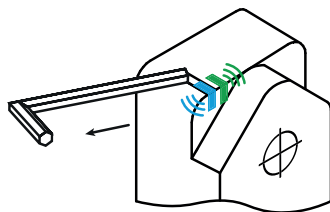

Withdraw the tool from the teaching field.

- Teaching operation successful: Sensor restores the factory settings. The LEDs are off for an instant and the sensor continues in standard operation (LED green continuous, other LEDs illuminate according to switching state).
- Teaching operation not successful: All LEDs are flashing fast for 8 s (8 Hz).

4.2.2 Measured values

Several measured values can be acyclically retrieved in the sensor using IO-Link. Further to distance measured values, frequency and counter values can be cyclically retrieved and hence are provided at reduced reaction time (see MDC source).

4.2.2.1 Distance/Frequency

Further to distance detected by the change in damping, the sensor would also output frequency and frequency-relevant measuring parameters based on distance.

For more detailed information on the following please refer to chapter [Annex \[▶ 45\]](#).

IO-Link access: measured values

Name	Index	Subindex	Description
Measurement Value.Distance	88	1	Distance measuring value
Measurement Value.Frequency	88	3	Frequency measuring value which is created by analyzing the distance. Measurement is independent of SSC settings.
Measurement Value.Amplitude	88	4	For diagnostics or for evaluating the application/set up for frequency measurements.
Measurement Value.Amplitude Offset	88	5	For diagnostics or for evaluating the application/set up for frequency measurements.

SSC 1 or 2 switch counts Amplitude Amplitude Offset Threshold SSC 1 or 2 (Setpoints)

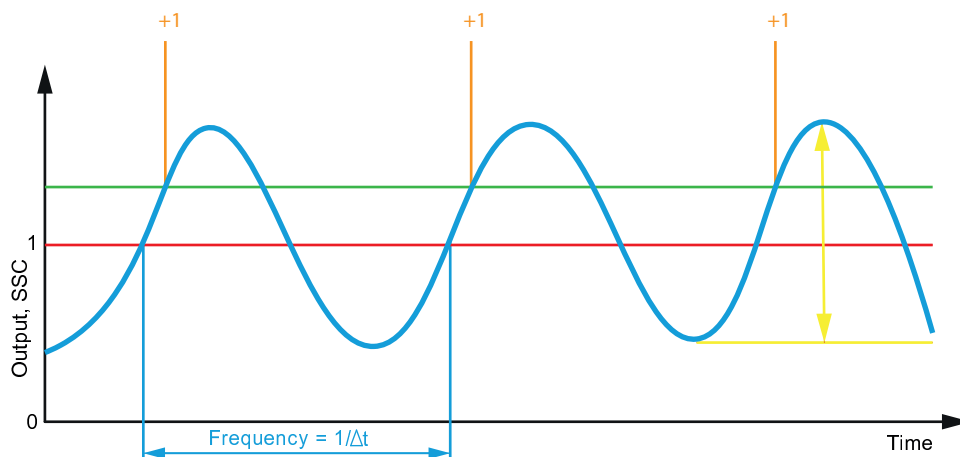

III. 3: Measured values

4.2.2.2 Counter

Each individual SSC implements a counter to be used for diagnostics or even as measured value. Setting the MDC source will map the count values of each channel to the measurement data channel (MDC).

Counter trigger is the positive edge of the associated SSC.



INFO

The count value intended for SSC4 configuration (source SSC1 or SSC2) is reset at every power-on.

The count values of the remaining SSCs are saved every 5 minutes. To avoid a loss of counts, execute *Store statistics* command prior to switch off.

Channel functions:

- SSC1 and SSC2: Signal channels for distance measurement
- SSC3: Frequency measurement
- SSC4: Counter

A source for SSC4 must be defined. The source counts the number of switching operations and provides the value to SSC4. Source must be either SSC1 or SSC2. The counter mapped as source for SSC4 is the one which is reset to zero at power-on. Disable is not possible, which means that either SSC1 or SSC2 will be set to zero at every sensor power on.

For more detailed information on the following please refer to chapter [Annex \[▶ 45\]](#).

IO-Link access: Counter

Name	Index	Subindex	Description
SSCx Switch Counts Re-setable	225	2, 12, 22, 32	SSCx Resetable Switch Counts
SSCx Switch Counts Reset	1000	–	Command to set the counter value of SSCx to zero. Available for SSC1, 2, 3 and 4.

Also see about this

[MDC source \[▶ 14\]](#)

4.2.3 MDC configuration

4.2.3.1 MDC source

This function defines which measured value is mapped on the MDC channel and this way will be provided via process data path **Process Data In (PDI)** for cyclic communication. Selecting SSC1, SSC2 or SSC4 provides the number of switches recognized by the channel.

For more detailed information on the following please refer to chapter [Annex \[▶ 45\]](#).

IO-Link access: MDC source

Name	Index	Subindex	Description
Source	83	1	Possible values: <ul style="list-style-type: none"> ▪ Distance ▪ Frequency ▪ SSC1 Switch Counter ▪ SSC2 Switch Counter ▪ SSC3 Switch Counter ▪ SSC4 Switch Counter

4.2.3.2 MDC descriptor

This function reads out the measuring range limits of the set MDC source. The sensor detecting a value out of range will come as *Out of range* error report (32760).

For more detailed information on the following please refer to chapter [Annex \[▶ 45\]](#).

IO-Link access: MDC source

Name	Index	Subindex	Description
Lower Limit	16512	1	Lower limit of the measuring range.
Upper Limit	16512	2	Upper limit of the measuring range.
Unit Code	16512	3	Shows the unit of the selected MDC source.
Scale	16512	4	

4.2.4 SSCx configuration

4.2.4.1 Switching points

They define distance (switching points) at which the switching output is to be activated.

Each SSC (Signal Switching Channel) can be defined switching points. Related switching bits are cyclically provided via IO-Link. Optionally, each SSC can be assigned a digital output.

The function can be configured via the following parameters:

- Select switching mode (*Single Point*, *Two Point* or *Window*).
- Define the switching point positions (*SP1* and *SP2*):
 - *Single Point*: *SP1*
 - *Two Point*: *SP1* and *SP2*
 - *Window*: *SP1* and *SP2*

For more detailed information on the following please refer to chapter [Annex ▸ 45](#).

IO-Link access: switching points

Name	Index	Subindex	Description
Setpoints.SSC1 Param SP1	60	1	...
Setpoints.SSC1 Param SP2	60	2	...
Setpoints.SSC2 Param SP1	62	1	...
Setpoints.SSC2 Param SP2	62	2	...
Setpoints.SSC3 Param SP1	16384	1	...
Setpoints.SSC3 Param SP2	16384	2	...
Setpoints.SSC4 Param SP1	16386	1	...
Setpoints.SSC4 Param SP2	16386	2	...



INFO

All LEDs light up for 1s when touching the teach field at the sensor with a ferromagnetic tool (tool has been recognized).

Teach access (Level 1): Single Point Mode

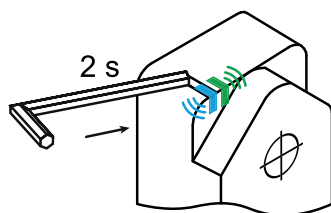

Touch the sensor's teach field with a ferromagnetic tool and hold for 2s. Once the sensor has recognized the tool all LEDs light up. After 2 seconds, the blue and green LEDs start flashing.

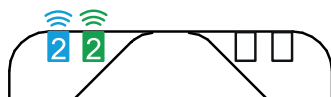

- Blue and green are LEDs flashing.

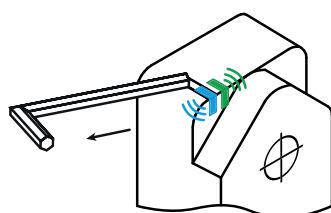

Withdraw the tool from the teaching field.

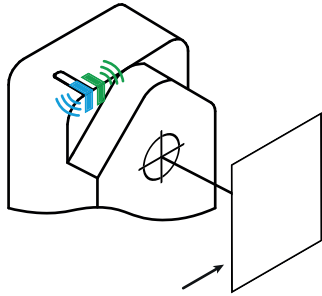

Place the object to be measured at the position you like to define as SP1.

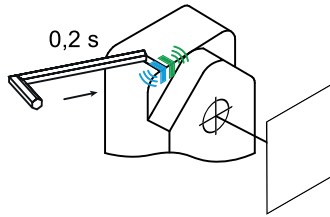

Briefly touch the teach field with the tool.

- The teaching operation was successful: the LEDs are off for an instant while the sensor continues in standard operation (LED green continuous, other LEDs illuminate according switching state).
- Teaching operation not successful: All LEDs are flashing fast for 8 s (8 Hz).

Teach access (Level 2): Window Mode/analog measuring field

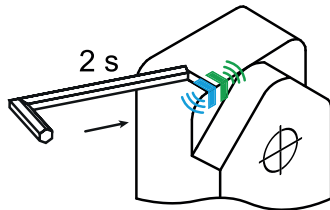

Touch the sensor's teach field with a ferromagnetic tool and hold for 4s. Once the sensor has recognized the tool all LEDs light up. After 2 seconds, the blue and green LEDs start flashing.



- Blue and green are LEDs flashing.

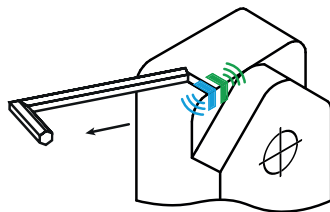

Withdraw the tool from the teaching field.

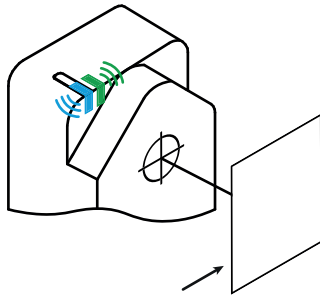

Place the object to be measured on the position to be defined as SP1/ start of measuring range.

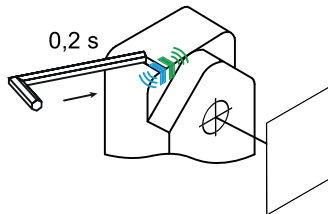

Briefly touch the teach field with the tool.

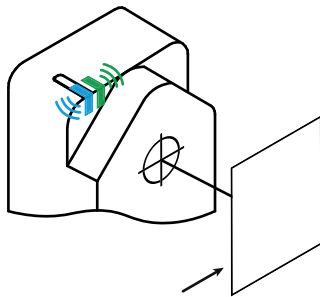

Place the object to be measured at the position to be defined as switching point SP2 / end of measuring range.

- Teaching operation successful: Sensor restores the factory settings. The LEDs are off for an instant and the sensor continues in standard operation (LED green continuous, other LEDs illuminate according to switching state).
- Teaching operation not successful: All LEDs are flashing fast for 8 s (8 Hz).

Also see about this

- [Switching mode](#) [▶ 20]
- [Switching logic](#) [▶ 18]
- [Hysteresis](#) [▶ 21]

4.2.4.2 Switching logic

Function *Switching logic* is for changing the switching output logic from normally open (NO, Normal) to normally closed (NC, Inverted).

Normal

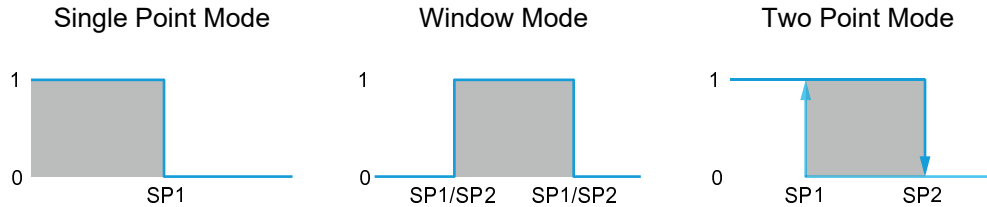

- The output is on High when the object is within defined the limits.
- The output is Low when no object is present or the object is outside the defined limits.

Inverted

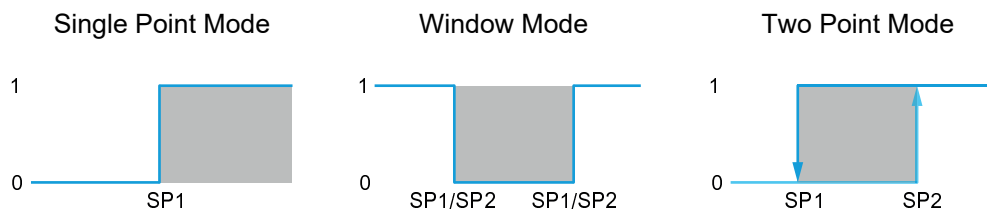

- The output is on High when no object is present or the object is outside the defined limits.
- The output is on Low when the object is within the range defined limits.

For more detailed information on the following please refer to chapter [Annex \[▶ 45\]](#).

IO-Link access: switching logic

Name	Index	Subindex	Description
SSC1 Config.Logic	61	1	Selects the SSC logic:
SSC2 Config.Logic	63	1	<ul style="list-style-type: none"> ■ <i>Normal</i>
SSC3 Config.Logic	16385	1	<ul style="list-style-type: none"> ■ <i>Inverted</i>
SSC4 Config.Logic	16387	1	

Teaching access: switching logic

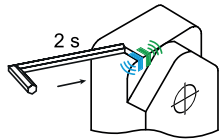

Touch the sensor's teach field with a ferromagnetic tool and hold for 6s. Once the sensor has recognized the tool all LEDs light up. After 2 seconds, the blue and green LEDs start flashing.



- Blue and green are LEDs flashing.

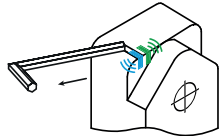

Withdraw the tool from the teaching field.

The LEDs indicate the set switching logic:

- LED green continuous: Switching logic NC (normally closed)
- LED amber continuous: Switching logic NO (normally open)

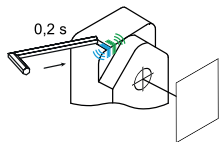

To change the switching logic, briefly touch the teach field with the tool.

Wait for 4 seconds to have the setting adopted.

- The teaching operation was successful: the LEDs are off for an instant while the sensor continues in standard operation (LED green continuous, other LEDs illuminate according switching state).
- Teaching operation not successful: All LEDs are flashing fast for 8 s (8 Hz).

4.2.4.3 Switching mode

This function sets the switching mode of the respective SSC.

There are the following modes:

- *Single Point*
- *Two Point* (only SSC1 and SSC2)
- *Window*

Single Point



Ill. 4: Sensor in measuring mode *Single Point*

- Purpose/Application (example referring to distance based SSC1 and SSC2):
 - Quality control: Check the minimum/maximum height of a measurement object.
 - Reach a desired position with a tool that edits an object.

Two Point (only SSC1 and SSC2)

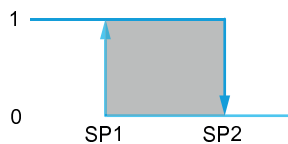

Ill. 5: Sensor in measuring mode *Two Point*

- Purpose/Application (example referring to distance based SSC1 and SSC2):
 - This mode specifies hysteresis as a concrete value. This is helpful for precise setting of switch-off point in addition to switch-on point.

Window

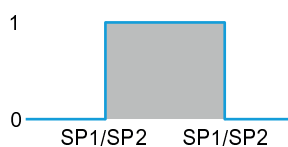

Ill. 6: Sensor in measuring mode *Window*

- Purpose/Application (example referring to distance based SSC1 and SSC2):
 - Quality control: Check dimensions of a measured object within a tolerance window.

For more detailed information on the following please refer to chapter [Annex \[▶ 45\]](#).

IO-Link access: Switching mode

Name	Index	Subindex	Description
SSC1 Config.Mode	61	2	Selects the SSC switch mode.
SSC2 Config.Mode	63	2	<ul style="list-style-type: none"> ▪ <i>Single Point</i>
SSC3 Config.Mode	16385	2	<ul style="list-style-type: none"> ▪ <i>Two Point</i> ▪ <i>Window</i>
SSC4 Config.Mode	16387	2	Selects the SSC switch mode. <ul style="list-style-type: none"> ▪ <i>Single Point</i> ▪ <i>Window</i>

4.2.4.4 Hysteresis

This function prevents unwanted switching operations by the switching output. The parameterized value of the hysteresis is the difference in distance between the points at which the switching output is activated and deactivated. Baumer recommends always setting the hysteresis not equal to 0.

Hysteresis is the difference between switching point and reset point. The following diagram shows the function principle:

- Light blue: object moving from far to near (here switching point)
- Dark blue: object moving from near to far (here reset point)

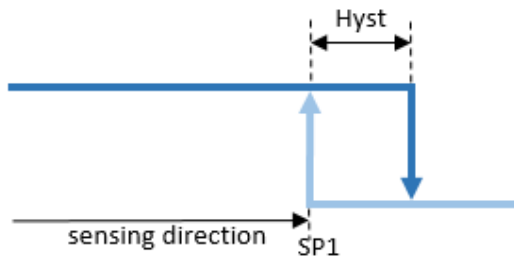

III. 7: Hysteresis

Hysteresis is specified in percent, i.e. in relation to the set switching distance.

Hysteresis alignment

Axial detection tasks such as stop trigger or limit detection require accurate sensing distance. To align switching behavior and hysteresis to the object's moving direction, the hysteresis orientation be modified.

This function ins only active in mode *Single Point* or *Window*.

Left Aligned (Negative hysteresis):

Hysteresis is aligned either to or against the sensing direction.

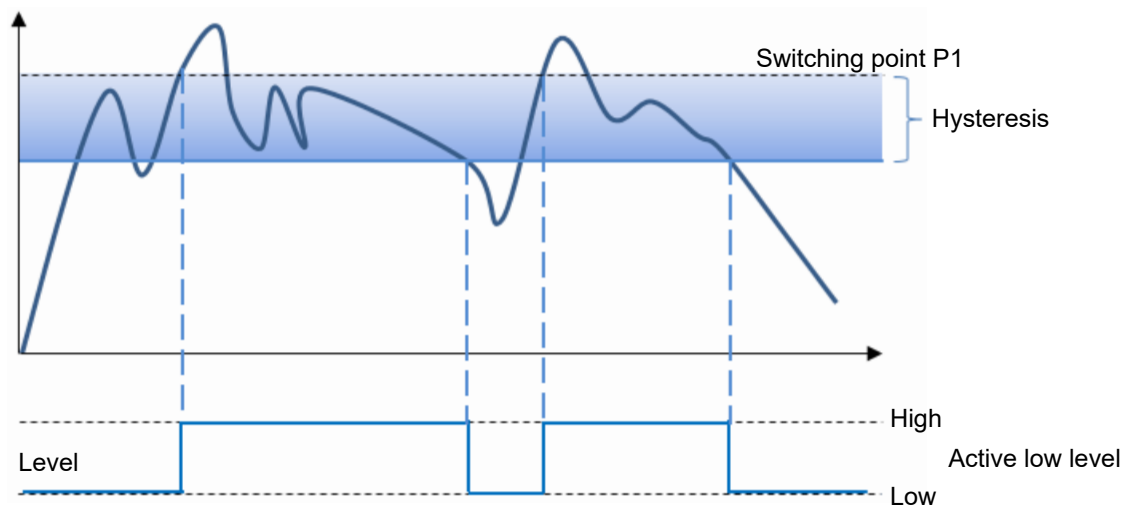

III. 8: Switching output behavior in mode *Single Point* and negative hysteresis (*Left Aligned*)

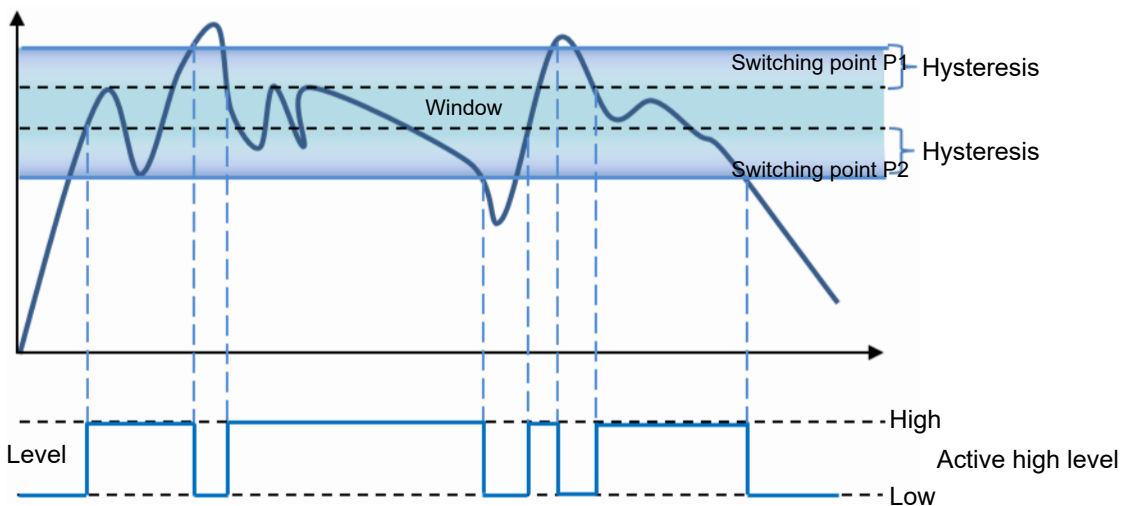

III. 9: Switching output behavior in mode *Window* and negative hysteresis (*Left Aligned*)

Right Aligned (Positive hysteresis):

Hysteresis is aligned to or against the sensing direction.

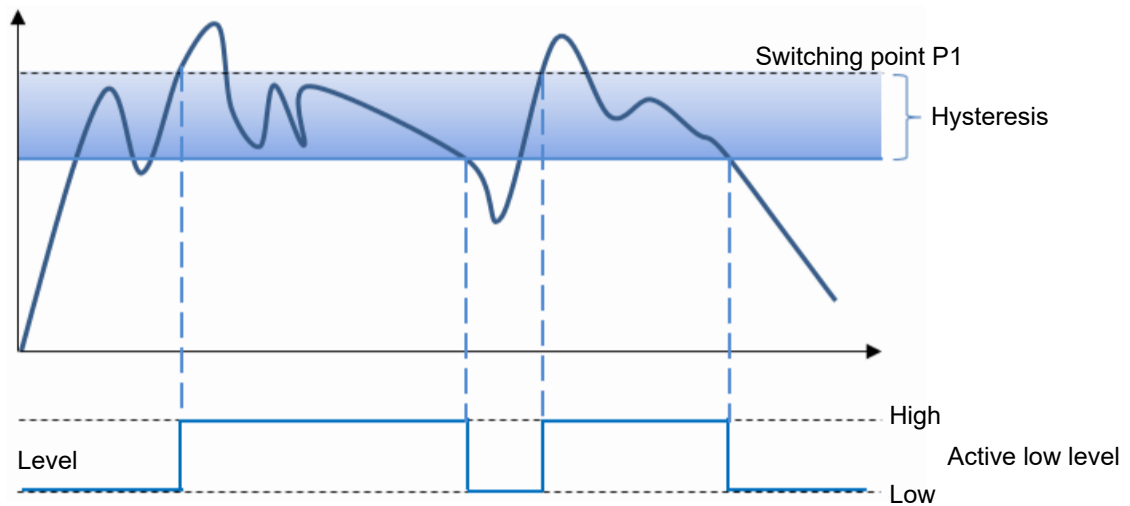

III. 10: Switching output behavior in mode *Single Point* and negative hysteresis (*Left Aligned*)

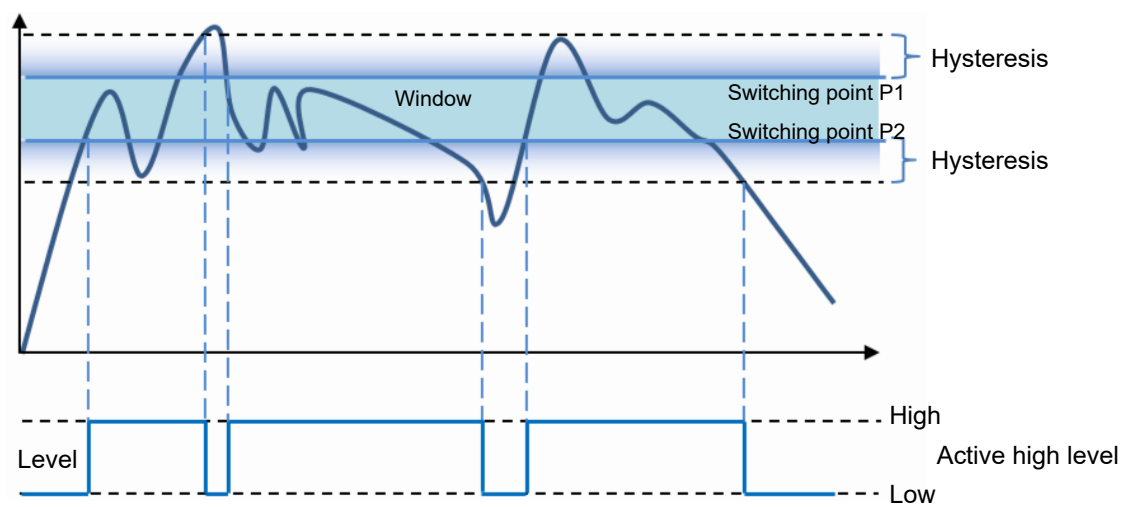

III. 11: Switching output behavior in mode *Window* and negative hysteresis (*Right Aligned*)

Center Aligned:

Compromise between positive and negative hysteresis. Hysteresis alignment is in symmetry to the individual target values.

For more detailed information on the following please refer to chapter [Annex | 45](#).

IO-Link access: hysteresis

Name	Index	Subindex	Description
SSC1 Config.Hyst	61	3	Select the hysteresis alignment mode:
SSC2 Config.Hyst	63	3	<ul style="list-style-type: none"> ■ Left Aligned
SSC3 Config.Hyst	16385	3	<ul style="list-style-type: none"> ■ Center Aligned ■ Right Aligned
Hysteresis.SSC1 Width	69	1	SSC Hysteresis Width
Hysteresis.SSC2 Width	69	11	
Hysteresis.SSC3 Width	69	21	

**INFO**

Sensor operation will no longer be reliable if the calculated hysteresis is outside the measuring range. It has to be ensured that hysteresis in combination with the set switching points SP1 and SP2 is always within the measuring range of 0 ... 32579.

Example: SP1 is on 32000, hysteresis 10% > switch-off point would equal 35320 which is outside the maximum limit of 32579.

4.2.4.5**Time filter**

This function is used to change the timing of the switching signals, e.g. to prevent bouncing or switching errors. Time parameterization and configuration straight at the sensor eliminates the need for PLC programming or the use of pulse stretching adapters.

Time filters can be individually configured and applied to each SSC.

Response Delay

Response Delay specifies the time the measured value must exceed (Single Point Mode) or be within (Window Mode) the switching points of the assigned SSC until its status would change to active (or inactive in inverted logic).

Possible fields of application:

- Suppression of inferior peaks/ switching errors, e.g. caused by structural changes in the background.
- To prevent switching errors caused by known potential interference, e.g. by mixers.
- To avoid bouncing contacts.
- For optimized execute time of downstream actuators triggered by the sensor output.

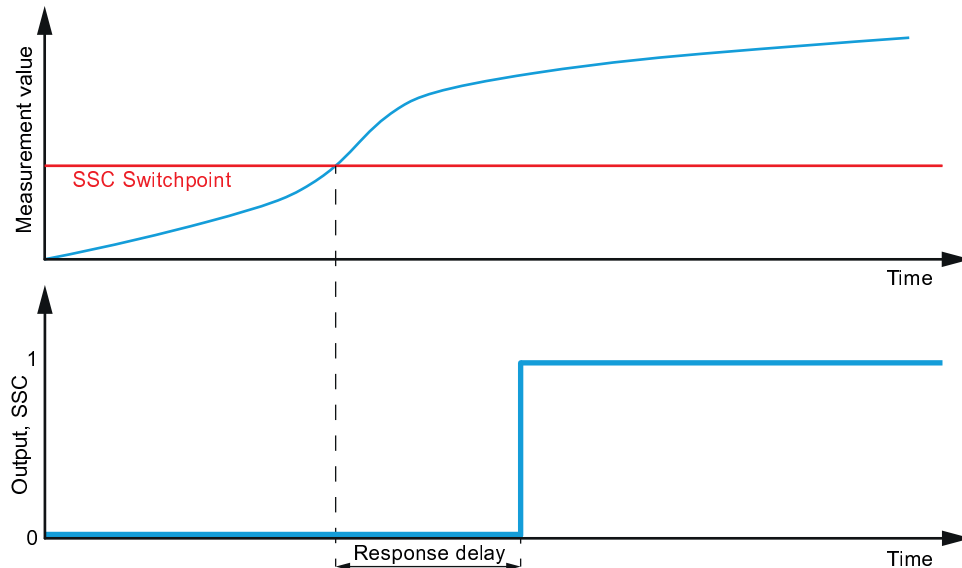

III. 12: Response Delay

Release Delay

Release Delay specifies the time the measured value must be inferior (Point Mode) or outside (Window Mode) the switching points of the assigned SSC until its status would change to inactive (or active in inverted logic).

Possible fields of application:

- Elimination of incorrect switching operations at objects that cannot be 100% safely detected throughout the entire length.
- To suppress short-time signal loss in current transmission caused by known interference, e.g. mixers.
- To avoid bouncing contacts.
- For optimized execute time of downstream actuators triggered by the sensor output.

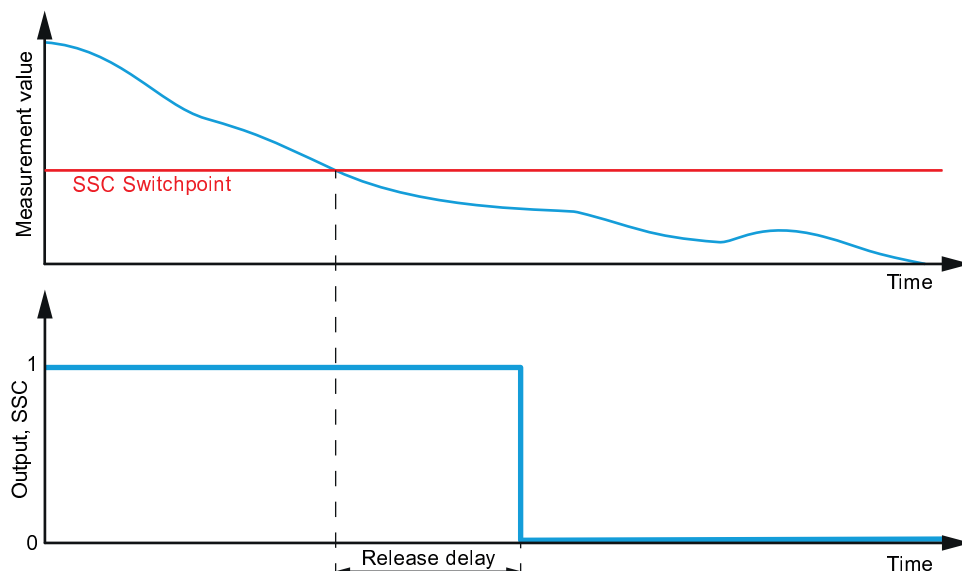

III. 13: Release Delay

Minimum Pulse Duration

Minimum Pulse Duration defines the minimum time the switching signal of the relevant SSC remains active or inactive after the status change.

Possible fields of application:

- Align sensor timing to a slower PLC.
- To avoid bouncing contacts.
- To avoid error pulses caused by short-time loss in correct signal transmission.
- For clock corrections.

Minimum Pulse Duration can be applied to:

- both slopes / active and inactive
- positive slope / active (or inactive, if the logic is inverted)
- negative slope / inactive (or active, if the logic is inverted)

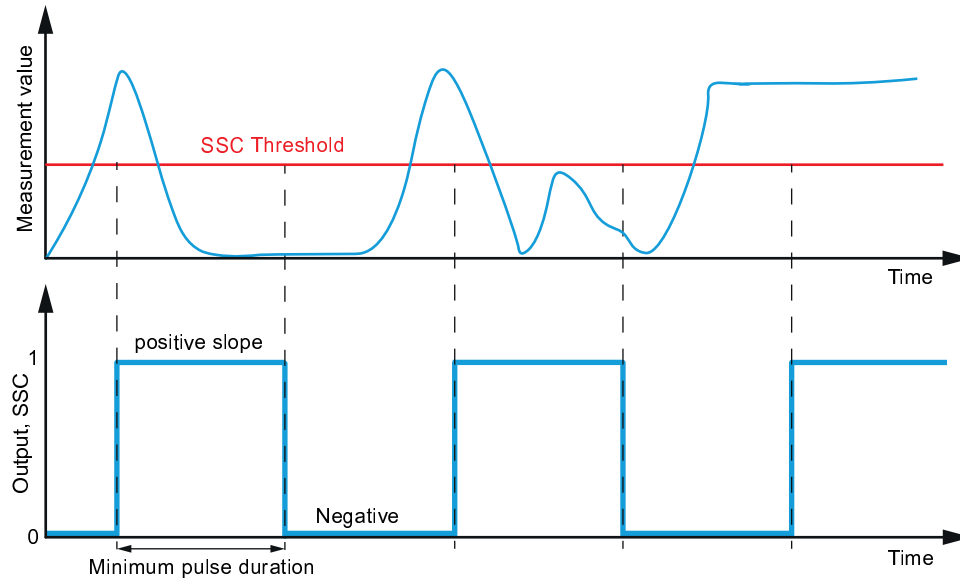

III. 14: *Minimum Pulse Duration*

For more detailed information on the following please refer to chapter [Annex \[▶ 45\]](#).

IO-Link access: Time filter

Name	Index	Subindex	Description
Response Delay.SSC1 Time	121	2	Sets the response delay time, available for SSC1, SSC2, SSC3 and SSC4
Response Delay.SSC2 Time	121	12	0 to 60.000 ms
Response Delay.SSC3 Time	121	22	
Response Delay.SSC4 Time	121	32	
Release Delay.SSC1 Time	120	2	Sets the release delay time, available for SSC1, SSC2, SSC3 and SSC4
Release Delay.SSC2 Time	120	12	
Release Delay.SSC3 Time	120	22	0 to 60.000 ms
Release Delay.SSC4 Time	120	32	
Minimum Pulse Dura- tion.SSC1 Time	122	2	Sets the minimum pulse duration, available for SSC1, SSC2, SSC3 and SSC4
Minimum Pulse Dura- tion.SSC2 Time	122	12	0 to 60.000 ms

Name	Index	Subindex	Description
Minimum Pulse Duration.SSC3 Time	122	22	
Minimum Pulse Duration.SSC4 Time	122	32	
Minimum Pulse Duration.SSC1 Mode	122	3	Selects the slope mode. <ul style="list-style-type: none"> ▪ <i>Both Slopes</i>
Minimum Pulse Duration.SSC2 Mode	122	13	<ul style="list-style-type: none"> ▪ <i>Positive Slope</i> ▪ <i>Negative Slope</i>
Minimum Pulse Duration.SSC3 Mode	122	23	
Minimum Pulse Duration.SSC4 Mode	122	33	

4.2.4.6 Counter / SSC4

Each individual SSC implements a counter which can be used as measured value or for diagnostics. The number of counts in each channel can be mapped to the measurement data channel (MDC) by setting the MDC source. Counter trigger is the positive edge of the associated SSC.

At sensor power on, the counter assigned to SSC 4 is automatically reset to zero, even with SSC4 being disabled.

SSC4 configuration allows for setup of a binary signal in relation with the number of SSC1 or SSC2 switching operations. Integrated auto-reset and time filter enable setup of a full-featured batch counter for lot sizes without the need for any PLC software programming.

SSC4 offers the same functions as SSC1 and SSC2 (based on distance measurement), including time filters. Exceptions:

- No hysteresis settings since there will be only incremental counts.
- Setting of additional parameters SSC4 source and SSC4 auto reset.

For more detailed information on the following please refer to chapter [Annex \[▶ 45\]](#).

IO-Link access: SSC4 configuration

Name	Index	Subindex	Description
Setpoints.SSC4 Param SP1	16386	1	Set the number of counts at which the SSC is set to active (or inactive if inverted)
Setpoints.SSC4 Param SP2	16386	2	Set the number of counts at at which the SSC is set to inactive (or active if inverted). This parameter is only active if SSC is set to window mode.
SSC4 Config.Logic	16387	1	Changes the Logic from NO to NC.
SSC4 Config.Mode	16387	2	Selection of the switching mode: <ul style="list-style-type: none"> ▪ Single Point ▪ Window
SSC4 Config.Selection	85	31	Selection of source for counter function:

Name	Index	Subindex	Description
			<ul style="list-style-type: none"> SSC1 Switch Counter SSC2 Switch Counter
SSC4 Config.Auto Reset	85	32	Autoreset of switch counter if given switch counts are reached. If autoreset is switched from disabled to enabled, the selected switch counter source is automatically being reset to zero.
Response Delay.SSC4 Time	121	32	Sets the response delay time, available for SSC1, SSC2, SSC3 and SSC4 0 to 60.000 ms
Release Delay.SSC4 Time	120	32	Sets the release delay time, available for SSC1, SSC2, SSC3 and SSC4 0 to 60.000 ms
Minimum Pulse Duration.SSC4 Time	122	32	Sets the minimum pulse duration, available for SSC1, SSC2, SSC3 and SSC4 0 to 60.000 ms
Minimum Pulse Duration.SSC4 Mode	122	33	Selects the slope mode. <ul style="list-style-type: none"> Both Slopes Positive Slope Negative Slope

SSC4 Config.Auto Reset enabled allows for setup of a full-featured batch counter for lot sizes without the need for any manual reset. Timing filters as response delay can help optimize the timing of a subsequent actor's execution.

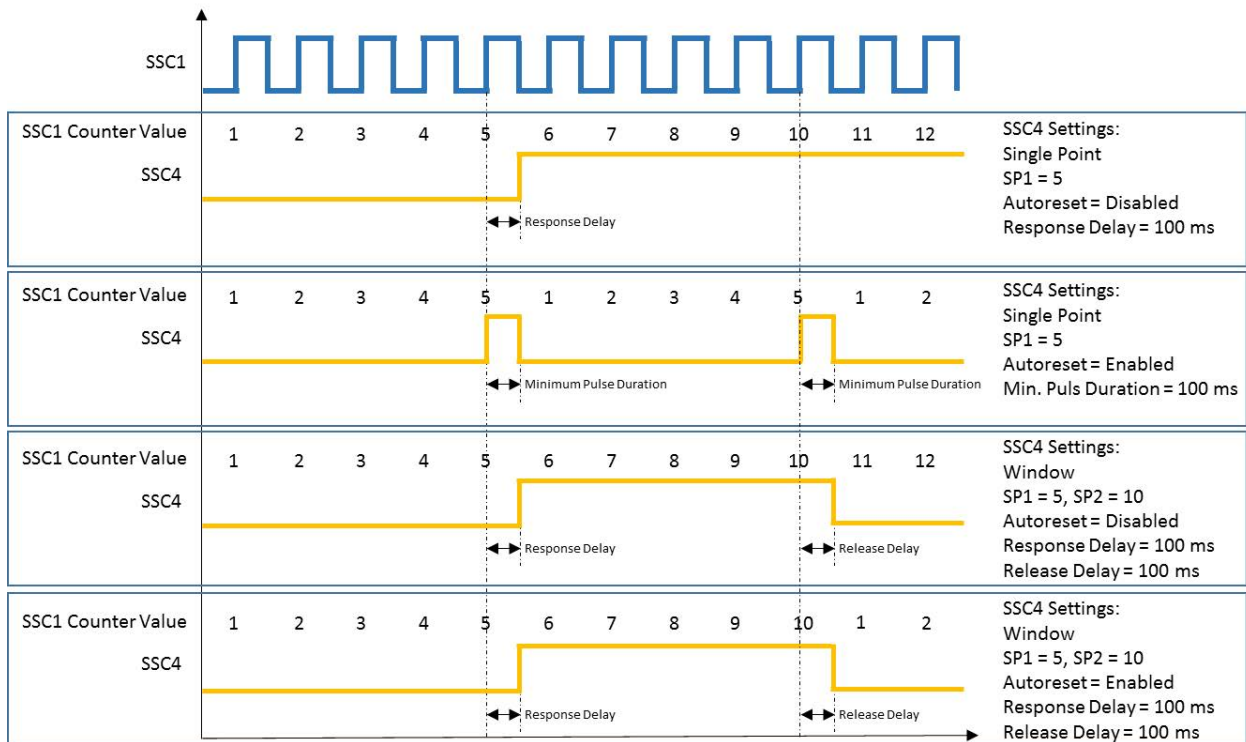

III. 15: SSC4/Counter behavior: Single Point or Window, Autoreset enabled or disabled

4.2.5 Teaching

Teach commands can be used for setting the switching points 1 and (SP1 and SP2). This is an easy way to compensate individual deviations such as mechanical backlash and mounting tolerances.

Two teaching methods are available:

- **Static:** Defines the target points by teaching the positions of non-moving objects.
- **Dynamic:** For moving and small objects. Analyzes minimum and maximum distance within a time window to define the target values.

The switching behavior of each individual switching signal channels depends on the respective configuration (e.g. switching mode, channel logic).

In addition, specific commands can be used for scaling the measured values in relation to real distance.

IO-Link access: Teaching

The teach commands can be applied to individual switching signal channels. Prior to the teaching operation, select SSC to be addressed.

Name	Index	Subindex	Description
TI Select	58	–	Selection of the SSC to which the teach-in is applied. Allowed values: <ul style="list-style-type: none"> ▪ SSC1 (default) ▪ SSC2 ▪ SSC3
TI Info.Mode of TI Select	103	1	Mode of the selected TI channel.
TI Result. Teach State	59	1	<ul style="list-style-type: none"> ▪ 0 – idle ▪ 1 – SP1 Success ▪ 2 – SP2 Success ▪ 3 – SP3 Success ▪ 4 – Waiting for Command ▪ 5 – Busy ▪ 7 – Error
TI Result. Teach Flag SP1	59	2	<ul style="list-style-type: none"> ▪ false – Not Taught ▪ true – Taught
TI Result. Teach Flag SP2	59	4	<ul style="list-style-type: none"> ▪ false – Not Taught ▪ true – Taught

4.2.5.1 Static teaching

Using teach commands, the switching points 1 and 2 (SP1 and SP2) are defined by placing the object at the desired position and executing the command. Which command is used in which order depends on the active switching mode of the selected teaching channel.

Teach-In in Single Point Mode

If selected SSC is configured as *Single Point Mode*, teaching SP1 is done as follows:

- Place object at the desired switching distance
- Execute *Teach SP1 (System Command)* for teaching the distance
- Execute *Teach Apply (System Command)* to save the target value

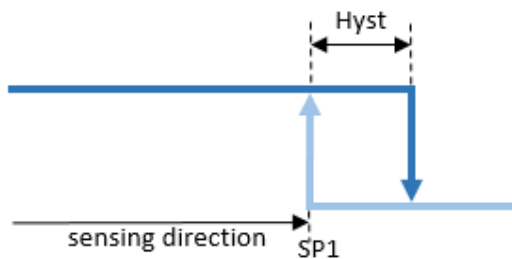

Ill. 16: *Single Point Teach*, switching behavior after successful teaching operation, hysteresis aligned to the right

Teach-In in Two Point Mode

If selected SSC is configured as *Two Point Mode*, proceed as following for teaching SP1 and SP2:

- Place object at the desired switching distance
- Execute *Teach SP1 (System Command)* to teach the distance assigned to SP1
- Execute *Teach SP2 (System Command)* to teach the distance assigned to SP2
- Execute *Teach Apply (System Command)* to save the target value

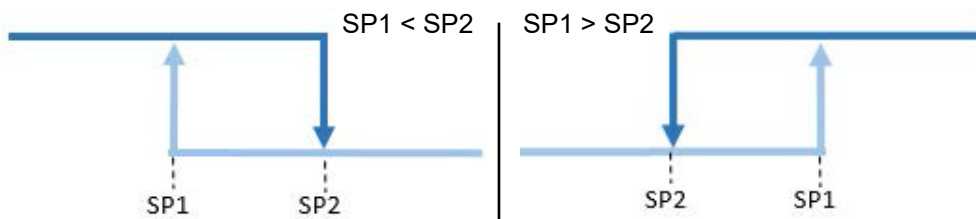

Ill. 17: *Two Point Teach*, switching behavior after successful teaching operation

Teach-In in Window Mode

If selected SSC is configured as *Window Mode*, proceed as following for teaching SP1 and SP2:

- Place object at the desired switching distance
- Execute *Teach SP1 (System Command)* to teach the distance assigned to SP1
- Execute *Teach SP2 (System Command)* to teach the distance assigned to SP2
- Execute *Teach Apply (System Command)* to save the target value

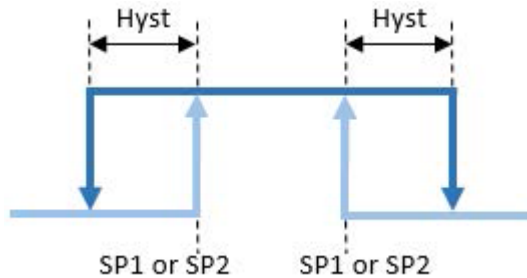

III. 18: *Window Teach*, switching behavior after successful teaching operation, hysteresis aligned to the right



INFO

Which SP was assigned the larger distance has no influence on the switching behavior (SP1<SP2, SP1>SP2).

For more detailed information on the following please refer to chapter [Annex \[▶ 45\]](#).

IO-Link access: Static teaching

Name	Index	Subindex	Description
Teach SP1 (System Command)	2	–	Set SP1 at the current position of the object which is within the scanning range.
Teach SP2 (System Command)	2	–	Set SP2 at the current position of the object which is within the scanning range.
Teach Apply (System Command)	2	–	Apply taught setpoints.
Teach Cancel (System Command)	2	–	Cancel teach procedure.

4.2.5.2 Dynamic teaching

Dynamic teaching allows for defining the target values by evaluation of the minimum and maximum measured values within a time frame. This is helpful for moving and/or small objects.

The command sequence for dynamic teaching is the same in every switching mode:

- Place object at the desired switching distance
- *Dynamic Teach SP Start (System Command)* to start the data acquisition.
- *Dynamic Teach SP Stop (System Command)* to stop the data acquisition.
- *Teach Apply (System Command)* execute to save the determined setpoints

For more detailed information on the following please refer to chapter [Annex \[▶ 45\]](#).

IO-Link access: Dynamic teaching

Name	Index	Subindex	Description
Dynamic Teach SP Start (System Command)	2	–	Set SP1 at the current position of the object which is within the scanning range.
Dynamic Teach SP Stop (System Command)	2	–	Set SP2 at the current position of the object which is within the scanning range.
Teach Apply (System Command)	2	–	Apply taught setpoints.
Teach Cancel (System Command)	2	–	Cancel teach procedure.

4.2.5.3 Scaling analog output

This function defines analog output scaling.

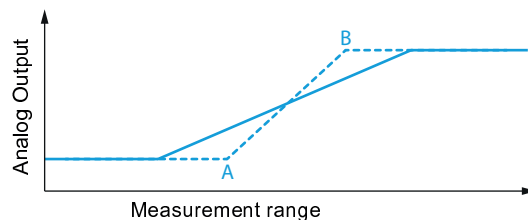

III. 19: Reduced value range of analog output to improve accuracy (analog value increasing with distance)

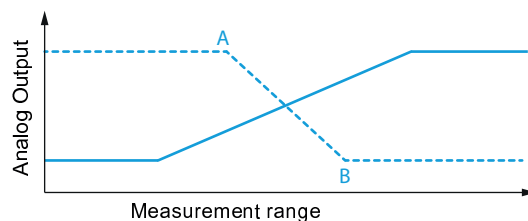

III. 20: Reduced and inverted value range of analog output for improved accuracy and different slope (analog value decreasing with distance)

IO-Link access: analog output

- Place object at the teaching position for minimum analog output limit, Position (A)
- *Execute Baumer Command "Output Scale Distance at Analog Min"*
- Place object at the teaching position for maximum analog output limit, position (B)
- *Execute Baumer Command "Output Scale Distance at Analog Max"*

Name	Index	Subindex	Description
Analog Scale Teach.Mode	202	5	Selects the teach mode: <ul style="list-style-type: none"> ▪ Single Point ▪ Fixed Slope Gradient
Analog Scale Teach.Status	202	3	Shows the status after teaching the scale
Baumer Command "Output Scale Distance at Analog Min"	1000	–	Sets the output scale distance at analog Min
Baumer Command "Output Scale Distance at Analog Max"	1000	–	Sets the output scale distance at analog Max

Teach access (Level 2): Single Point Mode switching output 2**INFO**

All LEDs light up for 1s when touching the teach field at the sensor with a ferromagnetic tool (tool has been recognized).

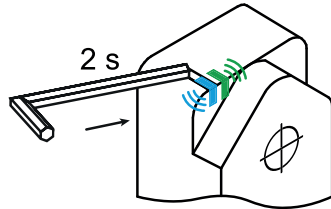

Touch the sensor's teach field with a ferromagnetic tool and hold for 4s. Once the sensor has recognized the tool all LEDs light up.



- The blue, green and yellow LEDs are flashing.

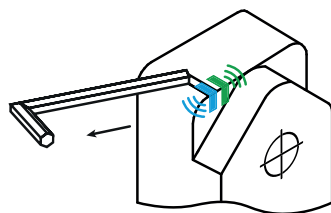

Withdraw the tool from the teaching field.

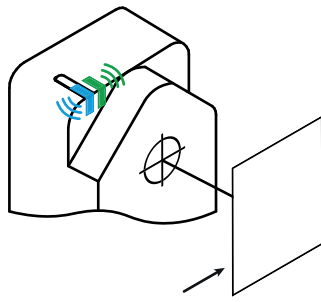

Place the object to be measured at the position to be defined as SP1.

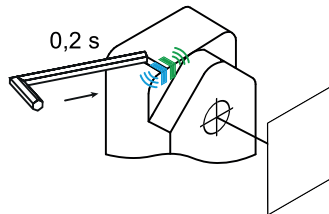

Briefly touch the teach field with the tool.

- The teaching operation was successful: the LEDs are off for an instant while the sensor continues in standard operation (LED green continuous, other LEDs illuminate according switching state).
- Teaching operation not successful: All LEDs are flashing fast for 8 s (8 Hz).

4.2.6 Signal processing

The following diagram is a rough overview on the signal processing chain. It starts with the measured value (top left) and ends either with a physical pin (top right) or our output via process data bottom right.

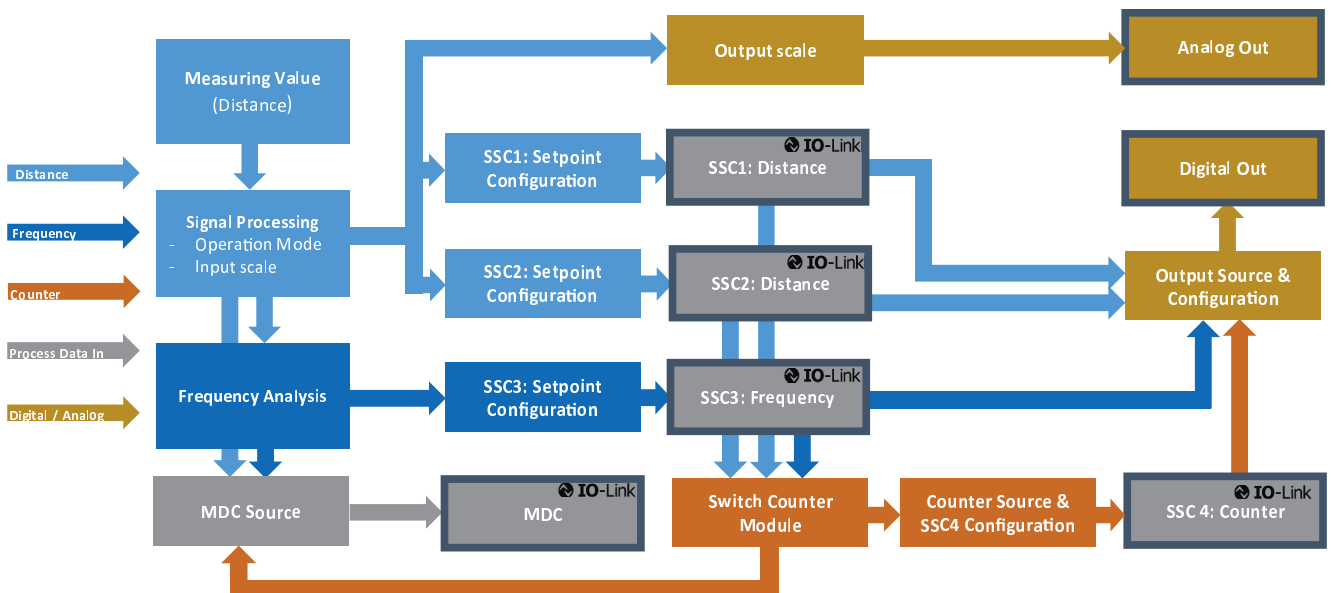

III. 21: Signal processing chain (diagram)

4.2.6.1 Filter / Measuring mode

This function is used to select predefined modes to achieve optimal results. Measuring frequency describes the limit frequency at which a measuring deviation of -3 dB will be recognized.

There are the following modes:

Mode	Measuring frequency	Switching frequency	Description
High Speed	<450 Hz	<800 Hz	Ideal for fast moving objects. The sensors are set to the fastest response time. Negative influence on signal-to-noise ratio.
Standard	<400 Hz	<500 Hz	Fair compromise between speed and signal-to-noise ratio.
Robust	<100 Hz	<150 Hz	Standard setting, fits most applications. The values in the data sheet refer to this mode.
High Accuracy	<6 Hz	<30 Hz	Setting with optimum signal-to-noise ratio.
High Pass Filter	300 Hz	>300 Hz	Helpful in frequency measurement >300 Hz or for analysis/detection of dynamic strokes.

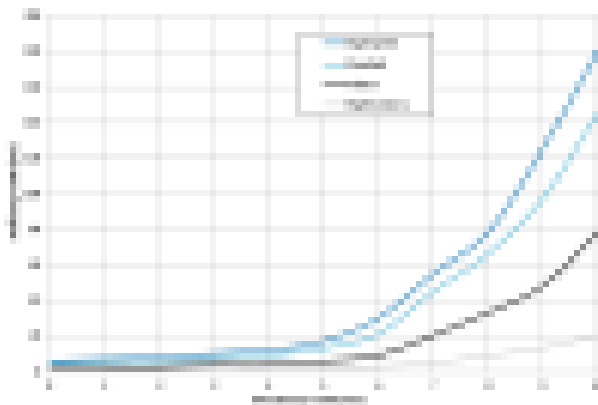

III. 22: Filter has an influence on resolution

For more detailed information on the following please refer to chapter [Annex \[▶ 45\]](#).

IO-Link access: Filter

Name	Index	Subindex	Description
Measurement Mode	77	1	Selection between High Speed, Standard, Robust, High Accuracy and High Pass Filter

4.2.6.2 Scaling of the input characteristic

This function is for adjusting the input characteristic.

With inductive sensors, the measuring behavior strongly depends on material, shape and dimensions of the object to be measured and, if flush mount, also on the surrounding materials. Function *Scaling of the input characteristic* is to compensate installation tolerances or scaling of the distance curve (real distance vs. measured value).

Minimum and maximum values can be individually adjusted:

- Manual fine-tuning of scaling by defining precise values

- Teach-in via IO-Link commands (recommended)

Single Point Mode

Individual teaching or adjustment of both positions is possible (*Corner 1, Corner 2*)

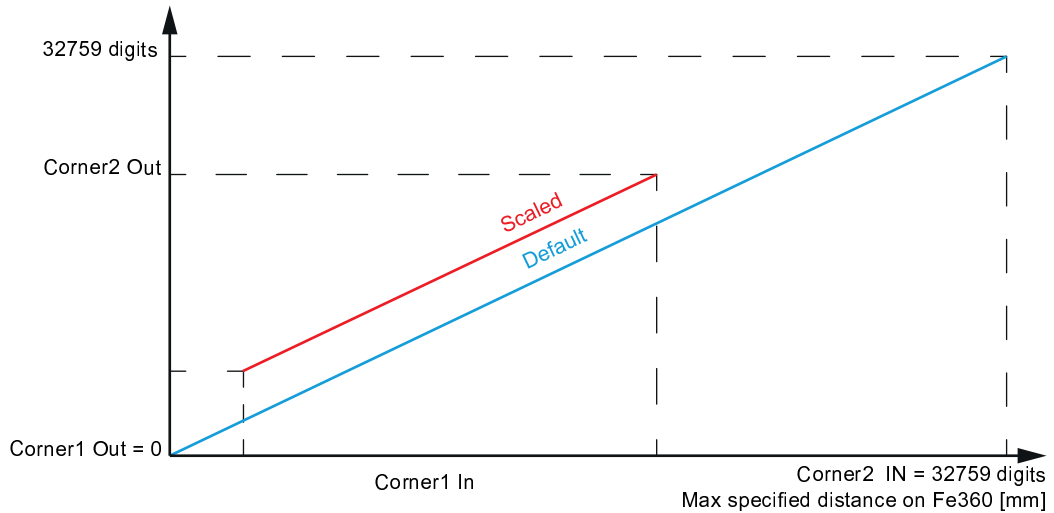

III. 23: Scaling - In vs out

This mode is for individual setting of start and end positions, for example scaling the measured values exactly to a defined measuring range to obtain a maximum linear behavior.



INFO

Settings in *Single Point Mode* result in the slope (digits/mm) deviating from the default characteristic curve.

Teaching commands define *Corner 1 In* and *Corner 2 In*. Usually, *Corner 1 Out* and *Corner 2 Out* remain at 0 and 32759 digits to achieve the maximum resolution. If required, *Corner 1 Out* and *Corner 2 Out* can be set manually.

Fixed Slope Gradient

Teaching of *Corner 1* defines the start of the measuring range under consideration of any permanent slope. This will ease offset compensation and zero point setting (if required). The resulting measured value starts at 0 and ends at 32759 minus the offset/*Corner 1 In*.

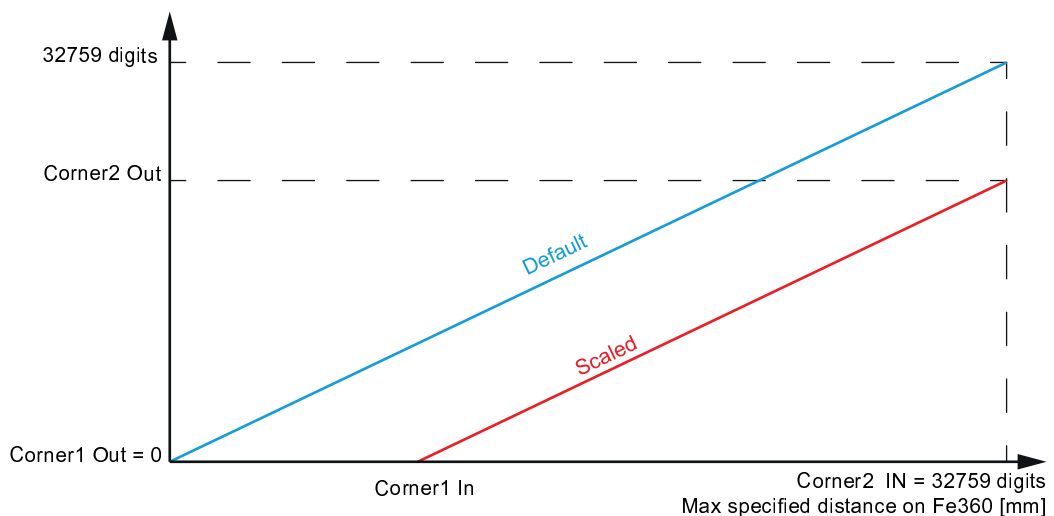

III. 24: Scaling – Fixed Slope Gradient, Teach Corner 1

Teaching of *Corner 2* defines the end of measuring range under consideration of any permanent slope. This simplifies offset compensation or zero point setting at the end of the measuring range. The resulting measured value ends at 32759 and starts at 32759 minus the offset/*Corner 2 In*.

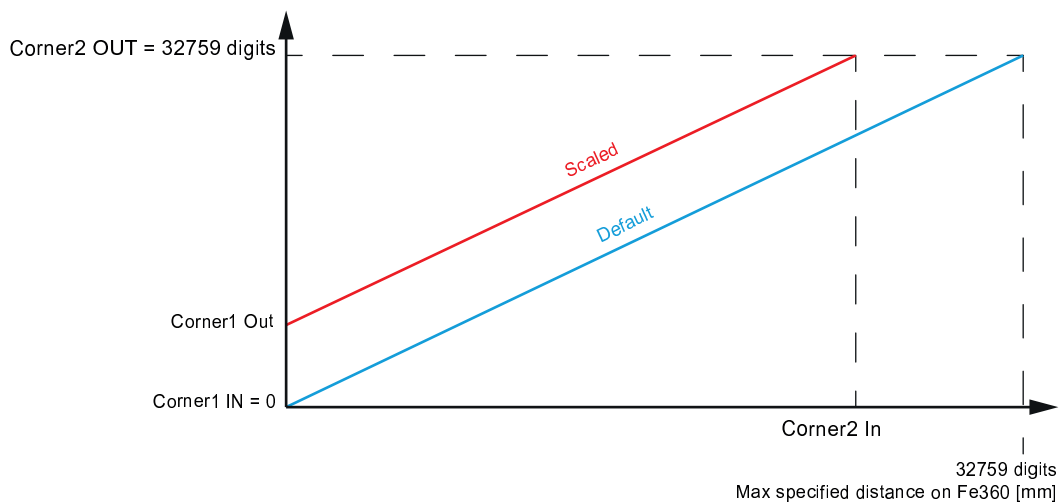

III. 25: Scaling – Fixed Slope Gradient, Teach Corner 2

For more detailed information on the following please refer to chapter [Annex \[▶ 45\]](#).

IO-Link access: Scaling

Name	Index	Subindex	Description
Input Scale.Enable	200	1	Enables/disables the Input Scale
Input Scale.Corner 1 In	200	2	Corner 1 input value of Input Scale
Input Scale.Corner 1 Out	200	3	Corner 1 output value of Output Scale
Input Scale.Corner 2 In	200	4	Corner 2 input value of Input Scale
Input Scale.Corner 2 Out	200	5	Corner 2 output value of Output Scale
Input Scale.Teach Mode	201	1	Selects the teach mode: <ul style="list-style-type: none"> ■ Single Point ■ Fixed Slope Gradient
Input Scale.Status	201	2	Shows the status after teaching the scale



INFO

Values for input scaling are only applied only the parameter *Input Scale.Enable* is on *Active*.

4.2.7 Input/Output Settings

4.2.7.1 Switching output

The line used by the IO-Link communication interface can also be used as a switching output (SIO mode). By default, it is connected to SSC1.

These parameters define the output circuit of the physical outputs. Set on Push-Pull, the type of switching output (change from NPN to PNP) enables change by external load according to the wiring diagram.

For connection diagrams please see data sheet.

Dual Channel allows for independent configuration of each output.

For more detailed information on the following please refer to chapter [Annex \[▶ 45\]](#).

IO-Link access: Switching output

Name	Index	Subindex	Description
DI/DO Settings.OUT1Circuit	78	1	Selection of circuit type. Allowed values: <ul style="list-style-type: none"> ▪ PNP Output ▪ Push-Pull Output (default)
DI/DO Settings.OUT1Mode	78	2	Selects the SSC channel that is shown on the Pin. Allowed values: <ul style="list-style-type: none"> ▪ None ▪ SCC1 - State (default) ▪ SCC2 - State ▪ SCC3 - State ▪ SCC4 - State
DI/DO Settings.OUT2Circuit	78	11	Selection of circuit type. Allowed values: <ul style="list-style-type: none"> ▪ PNP Output ▪ Push-Pull Output (default)
DI/DO Settings.OUT2Mode	78	12	Selects the SSC channel that is shown on the Pin. Allowed values: <ul style="list-style-type: none"> ▪ None ▪ SCC1 - State (default) ▪ SCC2 - State ▪ SCC3 - State ▪ SCC4 - State



INFO

Output 2 settings (OUT2) are only available with two-channel versions. Output 2 configuration is in the same way as output 1 (teaching modes, switching points, etc.).

4.2.7.2 Analog output

This function is used to configure the analog output.

Parameters *AnalogMax* and *AnalogMin* change the output characteristics. Reducing the measuring range will improve the resolution of the analog output.

The analog output can be inverted by setting *AnalogMax* to the minimum value (V) and *AnalogMin* to the maximum value (V) of the analog output.

For more detailed information on the following please refer to chapter [Annex \[▶ 45\]](#).

IO-Link access: analog output

Name	Index	Subindex	Description
Digits@Analog Min	202	2	Set the value in digit at the minimum value of the Analog Output
Analog Min	202	3	Set the minimum value of the analog output
Digits@Analog Max	202	4	Set the value in digit at the maximum value of the Analog Output
Analog Max	202	5	Set the maximum value of the analog output

4.2.8

Device access lock

4.2.8.1

Data Storage

This function prevents write access to the device parameters via Parameter Server.

For more detailed information on the following please refer to chapter [Annex \[▶ 45\]](#).

IO-Link access: Data Storage

Name	Index	Subindex	Description
Data Storage	12	2	

4.2.9

Local user interface

4.2.9.1

LED indicator

The sensor LEDs can be disabled or inverted.

Standard behavior of LED indicators:

Function	Green	Yellow
Power on	continuous	–
Short circuit	flashing	–
Output 1 active	–	continuous

The following settings are enabled:

- *On*: LED standard behavior by default (see previous table).
- *Off*: LED is disabled, except for function *Find Me* being enabled.
- *Inverted*: LED behavior inverted to default as in the previous table.

For more detailed information on the following please refer to chapter [Annex \[▶ 45\]](#).

IO-Link access: LED display

Name	Index	Subindex	Description
LED Settings.Green Mode	79	2	Power on/short circuit Allowed values: On/Off
LED Settings.Yellow Mode	79	12	Connected to output 1 (LED on if output 1 is active)

Name	Index	Subindex	Description
			Allowed values: On/Off/Inverted
LED Settings.Blue Mode	79	32	Allowed values: On/Off

IO-Link access: LED display

Name	Index	Subindex	Description
LED Settings.Green Mode	79	2	Power on/short circuit Allowed values: On/Off
LED Settings.Yellow Mode	79	12	Connected to output 1 (LED on if output 1 is active) Allowed values: On/Off/Inverted
LED Settings.Red Mode	79	22	Connected to output 2 (LED on if output 2 is active) Allowed values: On/Off/Inverted
LED Settings.Blue Mode	79	32	Allowed values: On/Off

4.2.9.2 *qTeach* lock

By default, *qTeach* is locked 5 min after switch-on to prevent unwanted manipulation. Lock can be disabled or locking time can be defined within the range 1 ... 120 min.

For more detailed information on the following please refer to chapter [Annex \[▶ 45\]](#).

IO-Link access: *qTeach* Lock

Name	Index	Subindex	Description
qTeach Time Out	80	1	<ul style="list-style-type: none"> ■ 0 = qTeach never locks ■ 0xFF = qTeach always off

4.3 Diagnostic functions

4.3.1 Operating hours

The operating time of the sensor is permanently recorded. This function reads out the total of the sensor's operating hours.

For more detailed information on the following please refer to chapter [Annex \[▶ 45\]](#).

IO-Link access: Operating hours

Name	Index	Subindex	Description
Baumer Command	1000	–	Operation Time Reset
Operation Time. Powerup	211	1	Powerup Operation Time
Operation Time. Resettable	211	2	Resettable Operation Time
Operation Time. Lifetime	211	3	Lifetime Operation Time
Unit Selection. Time	74	2	Selection between time units: <ul style="list-style-type: none"> ▪ Second ▪ Minute ▪ Hour

4.3.2 Device status

Function *Device status* is for requesting device status information.

For more detailed information on the following please refer to chapter [Annex \[▶ 45\]](#).

IO-Link access: Device status

Name	Index	Subindex	Description
Device Status	36	–	Indicator for the current device condition and diagnosis state. <ul style="list-style-type: none"> ▪ 0 – Device is OK ▪ 1 – Maintenance required ▪ 2 – Out of specification ▪ 3 – Functional check ▪ 4 – Failure
Detailed Device Status	37	1	–

4.3.3 Device temperature

This function reads the sensor's temperature information.

For more detailed information on the following please refer to chapter [Annex \[▶ 45\]](#).

IO-Link access: Device temperature

Name	Index	Subindex	Description
Baumer Command	1000	–	Device Temperature Reset
Device Temperature. Current	208	1	Current Device Temperature

Name	Index	Subindex	Description
Device Temperature. Min Resetable	208	2	Resetable Min Device Temperature
Device Temperature. Max Resetable	208	3	Resetable Max Device Temperature
Device Temperature. Min Lifetime	208	4	Minimum Device Temperature (over lifetime)
Device Temperature. Max Lifetime	208	5	Maximum Device Temperature (over lifetime)
Unit Selection. Temperature 74		1	Selection between temperature units: <ul style="list-style-type: none"> ▪ Kelvin ▪ Celsius ▪ Fahrenheit

4.3.4 Identification

These functions read or write sensor identification information.

For more detailed information on the following please refer to chapter [Annex \[▶ 45\]](#).

IO-Link access: Identification

Name	Index	Subindex	Description
Vendor Name	16	–	The vendor name that is assigned to a Vendor ID. Default value: Baumer Electric AG
Vendor Text	17	–	Additional information about the vendor. Default value: www.baumer.com
Product Name	18	–	Complete product name.
Product ID	19	–	Vendor-specific product or type identification (e.g. item number or model number).
Product Text	20	–	Additional product information for the device.
Application-specific Tag	24	–	Possibility to mark a device with user- or application-specific information.
Function Tag	25	–	User specified function tag.
Location Tag	26	–	User specified location tag.
Serial Number	21	–	Unique, vendor-specific identifier of the individual device.
Firmware Revision	23	–	Unique, vendor-specific identifier of the firmware revision of the individual device.
Hardware Revision	22	–	Unique, vendor-specific identifier of the hardware revision of the individual device.

4.3.5 Supply voltage

Function *Supply voltage* reads out the sensor's power supply information.

For more detailed information on the following please refer to chapter [Annex \[▶ 45\]](#).

IO-Link access: Supply voltage

Name	Index	Subindex	Description
Baumer Command	1000	–	Power Supply Voltage Reset
Power Supply. Current	210	1	Current Power Supply Voltage
Power Supply. Min Re- settable	210	2	Resettable Min Power Supply Voltage
Power Supply. Max Re- settable	210	3	Resettable Max Power Supply Voltage
Power Supply. Min Lifetime	210	4	Minimum Power Supply Voltage (over lifetime)
Power Supply. Max Lifetime	210	5	Maximum Power Supply Voltage (over lifetime)

4.3.6

Histogram

Continuous recording of different diagnostic and process values for predictive maintenance or troubleshooting. The values are stored in histograms. For doing so, the potential value range divides into several intervals (bins); counting the number of events a new value is added to a bin.

Range	-40 ... +125°C
Number of Bins	16 Bin
Size of a Bin	165°C / 16 = 10.31 °C
Range of Bin 1	-40 ... -20.69 °C
Range of Bin 2	-20.69 ... -10.37 °C
...	...
Range of Bin 16	+114.69 ... +120 °C

Tab. 3: Example based on device temperature

By extracting the corresponding bins and information via IO-Link, histograms can map the distribution of the values displayed.

Histograms are available for:

- Device Temperature, Lifetime
- Power Supply Voltage, Lifetime
- Process Value 1: Distance, Resettable
- Process Value 2: Frequency, Resettable

For device temperature and supply voltage, a measured value is recorded every 10 seconds. Every measurement of process values is recorded.

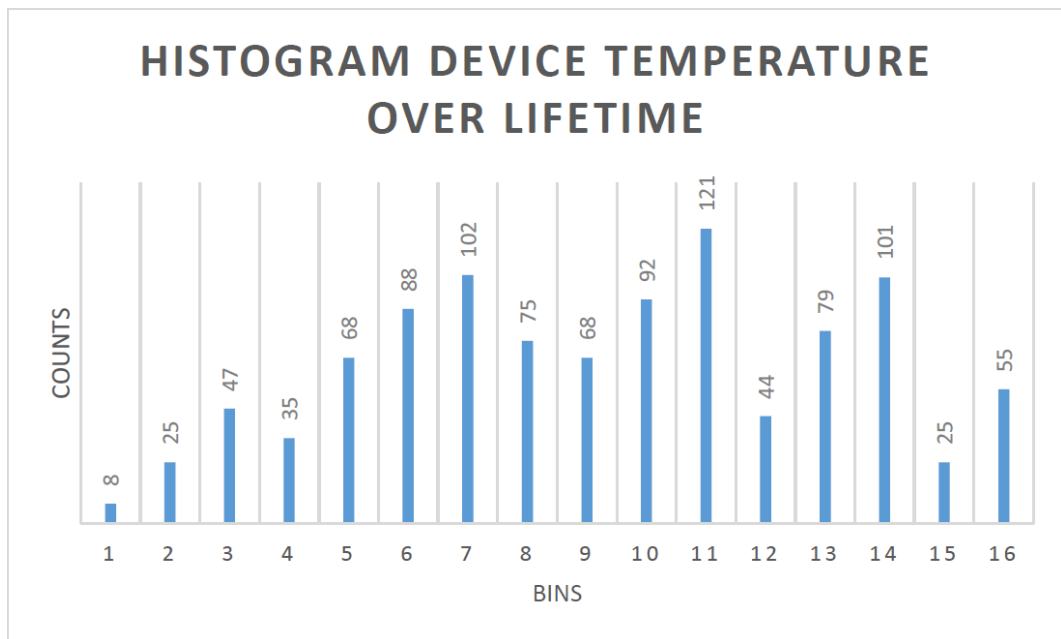

III. 26: Histogram of the device temperature (lifetime), example

The counts of each bin are stored as a 32-bit value.

For more detailed information on the following please refer to chapter [Annex \[45\]](#).

IO-Link access: Histogram voltage supply

Name	Index	Subindex	Description
Power Supply Voltage Life-time Histogram.Mode	262	1	Standard means: Linear partition of the range into bins.
Power Supply Voltage Life-time Histogram Unit	262	2	Indicates the unit
Power Supply Voltage Life-time Histogram RangeStart	262	3	Defines, where the range starts.
Power Supply Voltage Life-time Histogram RangeEnd	262	4	Defines, where the range ends.
Power Supply Voltage Life-time Histogram Nbr of Bins	262	5	Number of bins
Power Supply Voltage Life-time Histogram Bin1...16	262	11 ... 26	Number of counts of each bin

IO-Link access: Histogram device temperature

Name	Index	Subindex	Description
Temperature Lifetime Histogram.Mode	265	1	Standard means: Linear partition of the range into bins.
Temperature Lifetime Histogram Unit	265	2	Indicates the unit
Temperature Lifetime Histogram RangeStart	265	3	Defines, where the range starts.
Temperature Lifetime Histogram RangeEnd	265	4	Defines, where the range ends.
Temperature Lifetime Histogram Nbr of Bins	265	5	Number of bins
Temperature Lifetime Histogram Bin1...16	265	11 ... 26	Number of counts of each bin

IO-Link access: Histogram distance

Name	Index	Subindex	Description
Distance Resetable Histogram.Mode	257	1	Standard means: Linear partition of the range into bins.
Distance Resetable Histogram. Unit	257	2	Indicates the unit
Distance Resetable Histogram. RangeStart	257	3	Defines, where the range starts.
Distance Resetable Histogram. RangeEnd	257	4	Defines, where the range ends.
Distance Resetable Histogram.Nbr of Bins	257	5	Number of bins
Distance Resetable Histogram.Bin1...16	257	11 ... 26	Number of counts of each bin

IO-Link access: Histogram frequency

Name	Index	Subindex	Description
Frequency Resetable Histogram.Mode	260	1	Standard means: Linear partition of the range into bins.
Frequency Resetable Histogram. Unit	260	2	Indicates the unit
Frequency Resetable Histogram. RangeStart	260	3	Defines, where the range starts.
Frequency Resetable Histogram. RangeEnd	260	4	Defines, where the range ends.
Frequency Resetable Histogram.Nbr of Bins	260	5	Number of bins
Frequency Resetable Histogram.Bin1...16	260	11 ... 26	Number of counts of each bin

5 Annex

5.1 IO-Link

5.1.1 PDI

Example from PLP70:

subindex	bit offset	data type	allowed values	default value	acc. restr.	mod. other var.	excl. from DS	name	description
1	64	Boolean						Switch 1 Output	
2	65	Boolean						Active Alarms	
3	66	Boolean						Configuration Error	
4	67	Boolean						Current Out Error	
5	68	Boolean						Immersed	
6	32	32-bit UInteger						Output current	
7	0	Float32						Measured Value	

Octet 0

bit offset	71	70	69	68	67	66	65	64
subindex	//////	//////	//////	5	4	3	2	1

Octet 1

bit offset	63	62	61	60	59	58	57	56
subindex	6							
element bit	31	30	29	28	27	26	25	24

Octet 2

bit offset	55	54	53	52	51	50	49	48
subindex	6							
element bit	23	22	21	20	19	18	17	16

Octet 3

bit offset	47	46	45	44	43	42	41	40
subindex	6							
element bit	15	14	13	12	11	10	9	8

Octet 4

bit offset	39	38	37	36	35	34	33	32
subindex	6							
element bit	7	6	5	4	3	2	1	0

Octet 5

bit offset	31	30	29	28	27	26	25	24
subindex	7							
element bit	31	30	29	28	27	26	25	24

Octet 6

bit offset	23	22	21	20	19	18	17	16
subindex	7							
element bit	23	22	21	20	19	18	17	16

Octet 7

bit offset	15	14	13	12	11	10	9	8
subindex	7							
element bit	15	14	13	12	11	10	9	8

Octet 8

bit offset	7	6	5	4	3	2	1	0
subindex	7							
element bit	7	6	5	4	3	2	1	0

5.1.2 Identification

Index	Subindex	Name	Data type	Access rights	Value range	Description
16	0	Vendor Name	String	R	ASCII	Vendor name that is assigned to a vendor ID, e. g. Baumer.
17	0	Vendor Text	String	R	ASCII	Additional information about the vendor, e. g. www.baumer.com
18	0	Product Name	String	R	ASCII	Complete product name, e. g. IFxx.DxxL.
19	0	Product ID	String	R	ASCII	Vendor-specific product or type identification, e. g. item number or model number.
20	0	Product Text	String	R	ASCII	Additional product information for the device.
21	0	Serial number	String	R	ASCII	Unique, vendor-specific identifier of the individual device.
22	0	Hardware revision	String	R	ASCII	Unique, vendor-specific identifier of the hardware revision of the individual device, e. g. 00.00.01
23	0	Firmware Revision	String	R	ASCII	Unique, vendor-specific identifier of the firmware revision of the individual device, e. g. 00.00.04
24	0	Application specific Tag	String	R/W	ASCII	Possibility to mark a device with user-or application-specific information.
25	0	Function Tag	String	R/W	ASCII	Possibility to mark a device with function-specific information.
26	0	Location Tag	String	R/W	ASCII	Possibility to mark a device with location-specific information.

5.1.3 Parameter

5.1.3.1 System Commands

Index	Subindex	Name	Data type	Access rights	Value range	Description
2	0	System Command	Uint8	W		The parameters of the device are reset to factory settings. Note: A download of the data storage may be executed on the next power circle.

5.1.3.2

Measurement Values

Index	Subindex	Name	Data type	Access rights	Value range	Description
1000	–	Baumer Command (SSCx Switch Counts Reset)	Int32	W		Command to set the counter value of SSCx to zero. Available for SSC1, 2, 3 and 4.
225	2	SSC1 Switch Counts Resetable	Int32	R		SSC1 Resetable Switch Counts
225	12	SSC2 Switch Counts Resetable	Int32	R		SSC2 Resetable Switch Counts
225	22	SSC3 Switch Counts Resetable	Int32	R		SSC3 Resetable Switch Counts
225	32	SSC4 Switch Counts Resetable	Int32	R		SSC4 Resetable Switch Counts
88	1	Measurement Value.Distance	Int16	R		Distance measuring value
88	3	Measurement Value.Frequency	Int32	R		Frequency measuring value which is created by analyzing the distance. Measurement is independent of SSC settings.
88	4	Measurement Value.Amplitude	Int16	R		For diagnostics or for evaluating the application/set up for frequency measurements.
88	5	Measurement Value.Amplitude Off-set	Int16	R		For diagnostics or for evaluating the application/set up for frequency measurements.

5.1.3.3

MDC Configuration

Index	Subindex	Name	Data type	Access rights	Value range	Description
83	1	Source	Uint8	R/W		Defines the measuring value which is mapped to the MDC channel for availability via the process data IN path.
16512	1	Lower Limit	Uint32	R		Lower limit of the measuring range.
16512	2	Upper Limit	Uint32	R		Upper limit of the measuring range.
16512	3	Unit Code	Uint16	R		Shows the unit of the selected MDC source.
16512	4	Scale	Uint8	R		

5.1.3.4

SSC1 Configuration

Index	Subindex	Name	Data type	Access rights	Value range	Description
Setpoints						
60	1	Setpoints.SSC1 Param SP1	Uint32	R/W		
60	1	Setpoints.SSC1 Param SP2	Uint32	R/W		
Config						
61	1	SSC1 Config.Logic	Uint8	R/W		Selects the SSC logic: <ul style="list-style-type: none"> ▪ <i>Normal</i> ▪ <i>Inverted</i>
61	2	SSC1 Config.Mode	Uint8	R/W		Selects the SSC switch mode. <ul style="list-style-type: none"> ▪ <i>Single Point</i> ▪ <i>Two Point</i> ▪ <i>Window</i>

Index	Subindex	Name	Data type	Access rights	Value range	Description
61	3	SSC1 Config.Hyst	Uint16	R/W		Select the hysteresis alignment mode: <ul style="list-style-type: none"> Left Aligned Center Aligned Right Aligned
69	1	Hysteresis.SSC1 Width	Uint16	R/W		SSC Hysteresis Width
Time Filter						
121	2	Response Delay.SSC1 Time	Uint32	R/W		Sets the response delay time 0 to 60.000 ms
120	2	Release Delay.SSC1 Time	Uint32	R/W		Sets the release delay time 0 to 60.000 ms
122	2	Minimum Pulse Duration.SSC1 Time	Uint32	R/W		Sets the minimum pulse duration 0 to 60.000 ms
122	3	Minimum Pulse Duration.SSC1 Mode	Uint32	R/W		Selects the slope mode. <ul style="list-style-type: none"> Both Slopes Positive Slope Negative Slope

5.1.3.5

SSC2 Configuration

Index	Subindex	Name	Data type	Access rights	Value range	Description
Setpoints						
62	1	Setpoints.SSC2 Param SP1	Uint32	R/W		
62	2	Setpoints.SSC2 Param SP2	Uint32	R/W		

Index	Subindex	Name	Data type	Access rights	Value range	Description
Config						
63	1	SSC2 Config.Logic	Uint8	R/W		Selects the SSC logic: <ul style="list-style-type: none"> ▪ <i>Normal</i> ▪ <i>Inverted</i>
63	2	SSC2 Config.Mode	Uint8	R/W		Selects the SSC switch mode. <ul style="list-style-type: none"> ▪ <i>Single Point</i> ▪ <i>Two Point</i> ▪ <i>Window</i>
63	3	SSC2 Config.Hyst	Uint16	R/W		Select the hysteresis alignment mode: <ul style="list-style-type: none"> ▪ <i>Left Aligned</i> ▪ <i>Center Aligned</i> ▪ <i>Right Aligned</i>
69	11	Hysteresis.SSC2 Width	Uint16	R/W		SSC Hysteresis Width
Time Filter						
121	12	Response De- lay.SSC2 Time	Uint32	R/W		Sets the response delay time 0 to 60.000 ms
120	12	Release De- lay.SSC2 Time	Uint32	R/W		Sets the release delay time 0 to 60.000 ms
122	12	Minimum Pulse Du- ration.SSC2 Time	Uint32	R/W		Sets the minimum pulse duration 0 to 60.000 ms
122	13	Minimum Pulse Du- ration.SSC2 Mode	Uint32	R/W		Selects the slope mode. <ul style="list-style-type: none"> ▪ <i>Both Slopes</i> ▪ <i>Positive Slope</i> ▪ <i>Negative Slope</i>

5.1.3.6

SSC3 Configuration

Index	Subindex	Name	Data type	Access rights	Value range	Description
Setpoints						
16384	1	Setpoints.SSC3 Param SP1	Uint32	R/W		
16384	2	Setpoints.SSC3 Param SP2	Uint32	R/W		
Config						
16385	1	SSC3 Config.Logic	Uint8	R/W		Selects the SSC logic: <ul style="list-style-type: none"> ▪ <i>Normal</i> ▪ <i>Inverted</i>
16385	2	SSC3 Config.Mode	Uint8	R/W		Selects the SSC switch mode. <ul style="list-style-type: none"> ▪ <i>Single Point</i> ▪ <i>Two Point</i> ▪ <i>Window</i>
16385	3	SSC3 Config.Hyst	Uint16	R/W		Select the hysteresis alignment mode: <ul style="list-style-type: none"> ▪ <i>Left Aligned</i> ▪ <i>Center Aligned</i> ▪ <i>Right Aligned</i>
69	21	Hysteresis.SSC3 Width	Uint16	R/W		SSC Hysteresis Width
Time Filter						
121	22	Response De- lay.SSC3 Time	Uint32	R/W		Sets the response delay time 0 to 60.000 ms
120	22	Release De- lay.SSC3 Time	Uint32	R/W		Sets the release delay time 0 to 60.000 ms
122	22	Minimum Pulse Du- ration.SSC3 Time	Uint32	R/W		Sets the minimum pulse duration 0 to 60.000 ms

Index	Subindex	Name	Data type	Access rights	Value range	Description
122	23	Minimum Pulse Duration.SSC3 Mode	Uint32	R/W		Selects the slope mode. <ul style="list-style-type: none"> ▪ <i>Both Slopes</i> ▪ <i>Positive Slope</i> ▪ <i>Negative Slope</i>

5.1.3.7

SSC4 Configuration

Index	Subindex	Name	Data type	Access rights	Value range	Description
Setpoints						
16386	1	Setpoints.SSC4 Param SP1	Uint32	R/W		
16386	2	Setpoints.SSC4 Param SP2	Uint32	R/W		
Config						
16387	1	SSC4 Config.Logic	Uint8	R/W		Selects the SSC logic: <ul style="list-style-type: none"> ▪ <i>Normal</i> ▪ <i>Inverted</i>
16387	2	SSC4 Config.Mode	Uint8	R/W		Selects the SSC switch mode. <ul style="list-style-type: none"> ▪ <i>Single Point</i> ▪ <i>Window</i>
85	31	SSC4 Selection	Uint8	R/W		Selects the switch counter that is used as input of SSC4: <ul style="list-style-type: none"> ▪ <i>SSC1 Switch Counter</i> ▪ <i>SSC2 Switch Counter</i>
85	32	SSC4 Auto Reset	Uint16	R/W		Auto Reset of switch counter if value of SSC4 Param.SP1 (Single point) or Param.SP2 (Window) is reached. <ul style="list-style-type: none"> ▪ <i>Disabled</i> ▪ <i>Enabled</i>

Index	Subindex	Name	Data type	Access rights	Value range	Description
Time Filter						
121	32	Response Delay.SSC4 Time	Uint32	R/W		Sets the response delay time 0 to 60.000 ms
120	32	Release Delay.SSC4 Time	Uint32	R/W		Sets the release delay time 0 to 60.000 ms
122	32	Minimum Pulse Duration.SSC4 Time	Uint32	R/W		Sets the minimum pulse duration 0 to 60.000 ms
122	33	Minimum Pulse Duration.SSC4 Mode	Uint32	R/W		Selects the slope mode. <ul style="list-style-type: none"> ▪ <i>Both Slopes</i> ▪ <i>Positive Slope</i> ▪ <i>Negative Slope</i>

5.1.3.8**Teach**

Index	Subindex	Name	Data type	Access rights	Value range	Description
58	–	TI Select	Uint8	R/W		Selection of the SSC to which the teach-in is applied. Allowed values: <ul style="list-style-type: none"> ▪ SSC1 (default) ▪ SSC2 ▪ SSC3
103	1	TI Info.Mode of TI Select	Uint8	R		Mode of the selected TI channel.

Index	Subindex	Name	Data type	Access rights	Value range	Description
59	1	TI Result. Teach State	Uint8	R		<ul style="list-style-type: none"> ■ 0 – idle ■ 1 – SP1 Success ■ 2 – SP2 Success ■ 3 – SP3 Success ■ 4 – Waiting for Command ■ 5 – Busy ■ 7 – Error
59	2	TI Result. Teach Flag SP1	Boolean	R		<ul style="list-style-type: none"> ■ false – Not Taught ■ true – Taught
59	4	TI Result. Teach Flag SP2	Boolean	R		<ul style="list-style-type: none"> ■ false – Not Taught ■ true – Taught
Static						
2	–	Teach SP1 (System Command)	Uint8	W		Set SP1 at the current position of the object which is within the scanning range.
2	–	Teach SP2 (System Command)	Uint8	W		Set SP2 at the current position of the object which is within the scanning range.
2	–	Teach Apply (System Command)	Uint8	W		Apply taught setpoints.
2	–	Teach Cancel (System Command)	Uint8	W		Cancel teach procedure.
Dynamic						
2	–	Dynamic Teach SP Start (System Command)	Uint8	W		Set SP1 at the current position of the object which is within the scanning range.
2	–	Dynamic Teach SP Stop (System Command)	Uint8	W		Set SP2 at the current position of the object which is within the scanning range.
2	–	Teach Apply (System Command)	Uint8	W		Apply taught setpoints.

Index	Subindex	Name	Data type	Access rights	Value range	Description
2	–	Teach Cancel (System Command)	Uint8	W		Cancel teach procedure.
Input Scale						
1000	–	Teach Corner 1 (System Command)	Uint32	W		
1000	–	Teach Corner 2 (System Command)	Uint32	W		

5.1.3.9

Signal Processing

Index	Subindex	Name	Data type	Access rights	Value range	Description
77	1	Measurement Mode	Uint8	R/W		Selection between High Speed, Standard, Robust, High Accuracy and High Pass Filter
200	1	Input Scale.Enable	Uint8	R/W		Enables/disables the Input Scale
200	2	Input Scale.Corner 1 In	Uint32	R/W		Corner 1 input value of Input Scale
200	3	Input Scale.Corner 1 Out	Uint32	R/W		Corner 1 output value of Output Scale
200	4	Input Scale.Corner 2 In	Uint32	R/W		Corner 2 input value of Input Scale
200	5	Input Scale.Corner 2 Out	Uint32	R/W		Corner 2 output value of Output Scale
201	1	Input Scale.Teach Mode	Uint8	R/W		Selects the teach mode: <ul style="list-style-type: none"> ▪ Single Point ▪ Fixed Slope Gradient
201	2	Input Scale.Status	Uint32	R		Shows the status after teaching the scale

5.1.3.10

Input/Output Settings

Index	Subindex	Name	Data type	Access rights	Value range	Description
78	1	DI/DO Settings.OUT1Circuit	UInt8	R/W		Selection of circuit type. Allowed values: <ul style="list-style-type: none"> PNP Output Push-Pull Output (default)
78	2	DI/DO Settings.OUT1Mode	UInt16	R/W		Selects the SSC channel that is shown on the Pin. Allowed values: <ul style="list-style-type: none"> None SCC1 - State (default) SCC2 - State SCC3 - State SCC4 - State
78	11	DI/DO Settings.OUT2Circuit	UInt8	R/W		Selection of circuit type. Allowed values: <ul style="list-style-type: none"> PNP Output Push-Pull Output (default)
78	12	DI/DO Settings.OUT2Mode	UInt16	R/W		Selects the SSC channel that is shown on the Pin. Allowed values: <ul style="list-style-type: none"> None SCC1 - State (default) SCC2 - State SCC3 - State SCC4 - State

5.1.3.11**Local User Interface**

Index	Subindex	Name	Data type	Access rights	Value range	Description
80	1	qTeach Time Out	Int8	R/W		<ul style="list-style-type: none"> ■ 0 = qTeach never locks ■ 0xFF = qTeach always off
79	2	LED Settings.Green Mode	Int8	R/W		Power on/short circuit Allowed values: On/Off
79	12	LED Settings.Yellow Mode	Int8	R/W		Connected to output 1 (LED on if output 1 is active) Allowed values: On/Off/Inverted
79	32	LED Settings.Blue Mode	Int8	R/W		Allowed values: On/Off

5.1.3.12**Device Access Locks**

Index	Subindex	Name	Data type	Access rights	Value range	Description
12	2	Data Storage	Boolean	R/W		

5.1.4

5.1.4.1

Diagnosis

Device Status

Index	Subindex	Name	Data type	Access rights	Value range	Description
37	1	Device Status		R		Indicator for the current device condition and diagnosis state. <ul style="list-style-type: none"> ▪ 0 – Device is OK ▪ 1 – Maintenance required ▪ 2 – Out of specification ▪ 3 – Functional check ▪ 4 – Failure
36	0	Detailed Device Status	Uint8	R		–

5.1.4.2

Device Temperature

Index	Subindex	Name	Data type	Access rights	Value range	Description
1000	–	Baumer Command	Int32	W		Device Temperature Reset
208	1	Device Temperature. Current	Int32	R		Current Device Temperature
208	2	Device Temperature. Min Resettable	Int32	R		Resettable Min Device Temperature
208	3	Device Temperature. Max Resettable	Int32	R		Resettable Max Device Temperature
208	4	Device Temperature. Min Lifetime	Int32	R		Minimum Device Temperature (over lifetime)
208	5	Device Temperature. Max Lifetime	Int32	R		Maximum Device Temperature (over lifetime)
74	1	Unit Selection. Temperature	Int16	R/W		Selection between temperature units: <ul style="list-style-type: none"> ▪ Kelvin ▪ Celsius ▪ Fahrenheit

5.1.4.3

Operation Time

Index	Subindex	Name	Data type	Access rights	Value range	Description
1000	–	Baumer Command	Int32	W		Operation Time Reset
211	1	Operation Time. Powerup	Int32	R		Powerup Operation Time
211	2	Operation Time. Re-settable	Int32	R		Resettable Operation Time
211	3	Operation Time. Lifetime	Int32	R		Lifetime Operation Time
74	2	Unit Selection. Time	Int16	R/W		Selection between time units: <ul style="list-style-type: none"> ■ Second ■ Minute ■ Hour

5.1.4.4

Power Supply

Index	Subindex	Name	Data type	Access rights	Value range	Description
1000	–	Baumer Command	Int32	W		Power Supply Voltage Reset
210	1	Power Supply. Current	Int32	R		Current Power Supply Voltage
210	2	Power Supply. Min Resettable	Int32	R		Resettable Min Power Supply Voltage
210	3	Power Supply. Max Resettable	Int32	R		Resettable Max Power Supply Voltage
210	4	Power Supply. Min Lifetime	Int32	R		Minimum Power Supply Voltage (over lifetime)
210	5	Power Supply. Max Lifetime	Int32	R		Maximum Power Supply Voltage (over lifetime)

5.1.4.5

Histogram

Index	Subindex	Name	Data type	Access rights	Value range	Description
Power Supply						
262	1	Power Supply Voltage Lifetime Histogram.Mode	Uint8	R		Standard means: Linear partition of the range into bins.
262	2	Power Supply Voltage Lifetime Histogram Unit	Uint16	R		Indicates the unit
262	3	Power Supply Voltage Lifetime Histogram RangeStart	Uint32	R		Defines, where the range starts.
262	4	Power Supply Voltage Lifetime Histogram RangeEnd	Uint32	R		Defines, where the range ends.
262	5	Power Supply Voltage Lifetime Histogram Nbr of Bins	Uint8	R		Number of bins
262	11 ... 26	Power Supply Voltage Lifetime Histogram Bin1...16	Uint32	R		Number of counts of each bin

Index	Subindex	Name	Data type	Access rights	Value range	Description
Device Temperature						
265	1	Temperature Life-time Histogram.Mode	Uint8	R		Standard means: Linear partition of the range into bins.
265	2	Temperature Life-time Histogram Unit	Uint16	R		Indicates the unit
265	3	Temperature Life-time Histogram RangeStart	Uint32	R		Defines, where the range starts.
265	4	Temperature Life-time Histogram RangeEnd	Uint32	R		Defines, where the range ends.
265	5	Temperature Life-time Histogram Nbr of Bins	Uint8	R		Number of bins
265	11 ... 26	Temperature Life-time Histogram Bin1...16	Uint32	R		Number of counts of each bin
Distance						
1000	–	Baumer Command	Int32	W		Distance Histogram Reset
257	1	Distance Resetable Histogram.Mode	Uint8	R		Standard means: Linear partition of the range into bins.
257	2	Distance Resetable Histogram. Unit	Uint16	R		Indicates the unit
257	3	Distance Resetable Histogram. RangeStart	Uint32	R		Defines, where the range starts.
257	4	Distance Resetable Histogram. RangeEnd	Uint32	R		Defines, where the range ends.

Index	Subindex	Name	Data type	Access rights	Value range	Description
257	5	Distance Resetable Histogram.Nbr of Bins	Uint8	R		Number of bins
257	11 ... 26	Distance Resetable Histogram.Bin1...16	Uint32	R		Number of counts of each bin
Frequency						
1000	–	Baumer Command	Int32	W		Frequency Histogram Reset
260	1	Frequency Re-setable Histogram.Mode	Uint8	R		Standard means: Linear partition of the range into bins.
260	2	Frequency Re-setable Histogram.Unit	Uint16	R		Indicates the unit
260	3	Frequency Re-setable Histogram.RangeStart	Uint32	R		Defines, where the range starts.
260	4	Frequency Re-setable Histogram.RangeEnd	Uint32	R		Defines, where the range ends.
260	5	Frequency Re-setable Histogram.Nbr of Bins	Uint8	R		Number of bins
260	11 ... 26	Frequency Re-setable Histogram.Bin1...16	Uint32	R		Number of counts of each bin

5.2 qTeach®

5.2.1 Teach level overview

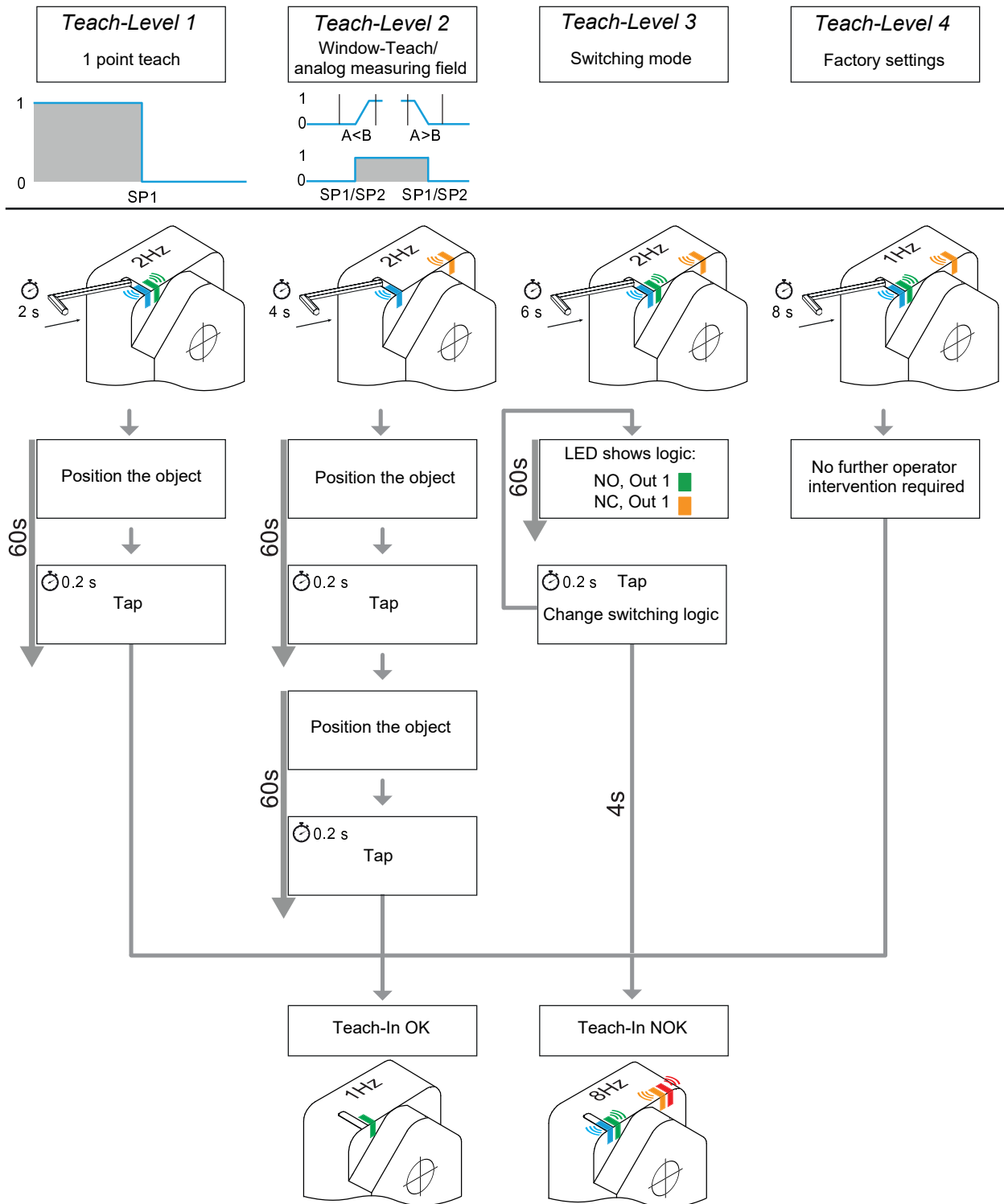

■ LED permanently illuminated
 ⏏ LED flashing at the specified frequency
 Ferromagnetic object

⌚ 0.2 s Touch the sensor's teach field with a ferromagnetic tool and hold for the specified time

